

Optimotion Implants

Blue Total Knee System

Surgical Technique Guide

Optimotion Implants, LLC.
6052 Turkey Lake Road,
Suite # 170
Orlando, FL 32819

Phone: 877-OPT-MOTN (877-678-6686)
Email: support@optimotionimplants.com
Website: www.optimotionimplants.com



Before using this product, read the following information thoroughly.

Introduction

The Optimotion™ Blue Total Knee Arthroplasty (TKA) System is a total knee replacement system designed for patients suffering from disabling joint disease of the knee resulting from a multitude of factors including primary osteoarthritis, posttraumatic osteoarthritis, autoimmune mediated arthritis (rheumatoid), and avascular necrosis. Optimotion™ Blue is a contemporary, fixed bearing, TKA system designed with features to enhance both cemented and porous implant fixation. The system includes **Femoral Components, Tibial Trays, Tibial Inserts, and Patella implants**. All of the implants are sized to fit a wide range of the skeletally mature patient population. The cruciate retaining (CR) **Femoral Component** options include both cemented and uncemented (porous) options. The cobalt chrome alloy porous **Uncemented Femoral Component** options have a porous sintered bead cobalt chrome coating. The **Tibial Tray** options include a non-porous **Cemented Tibial Tray** made from titanium alloy and a porous **Uncemented Tibia Tray** made by an additive manufacturing (AM) process from the same titanium alloy. The **Uncemented Tibia Tray** has an integrated ultra-porous titanium alloy bone apposition surface which is designed to be used with or without bone cement. The **Tibial Trays** can be assembled with or without a **Tibial Stem** (made from titanium alloy) depending on surgeon preference. The system offers modular **Tibial Inserts** that are either asymmetric CR or symmetric Highly Congruent (HC) CR and symmetric **Patella Components** that allow surgeons to adjust for a patient's size, bone quality and stock, as well ligament laxity and stability. Patella Components are provided as either full polymer **Cemented Patella Components** or porous metal-backed **Uncemented Patella Components**¹.

Features

Advanced Porous Additive Manufactured (AM) Technology: The **Uncemented Tibial Trays, Uncemented Femoral Components, and Uncemented Porous Metal-Backed Patella Components** have porous coatings on the majority of the bone contacting surfaces to maximize interface coverage for biological fixation. The **Uncemented Tibial Tray and Patella** are additively manufactured (AM) to include Ultra-Porous Technology. The AM Ultra-Porous Technology of irregularly shaped random interconnected pores create a three-dimensional porous shape.

Advanced Polymer Bearing Surface Technology: The **Tibial Inserts** and the **Patella Components** are machined from compression molded, highly cross-linked, Vitamin-E enhanced, Ultra High Molecular Weight Polyethylene (UHMWPE).

¹Please see 102-SRG01 Porous Metal-Backed Patella Surgical Technique Guide for cementless patella preparation.

Optimotion Implants Blue Total Knee System

Surgical Technique Guide

Modularity of the Implants: The design philosophy of Optimotion™ Blue allows for modularity and interchangeability between the components (Figure 1).

- There are two types of **Tibial Trays**, cemented and uncemented, both allowing for **Tibial Stems** to be inserted in the distal keel to enhance distal fixation if needed. The **Tibial Trays** are universal and can be used on left or right knees.
- There are two types of **Tibial Inserts**, Cruciate Retaining (CR) and Highly Congruent CR (HCCR). The **CR Tibial Inserts** are available in Left or Right and the **HCCR Tibial Inserts** are universal and can be used on left or right knees. **Tibial Insert** components allow surgeons to adjust for a patient's bone quality and stock as well ligament stability.
- The two types of **Femoral Components**, (cemented and uncemented) all articulate on either the CR or the HCCR **Tibial Inserts** and are available in left and right configurations.

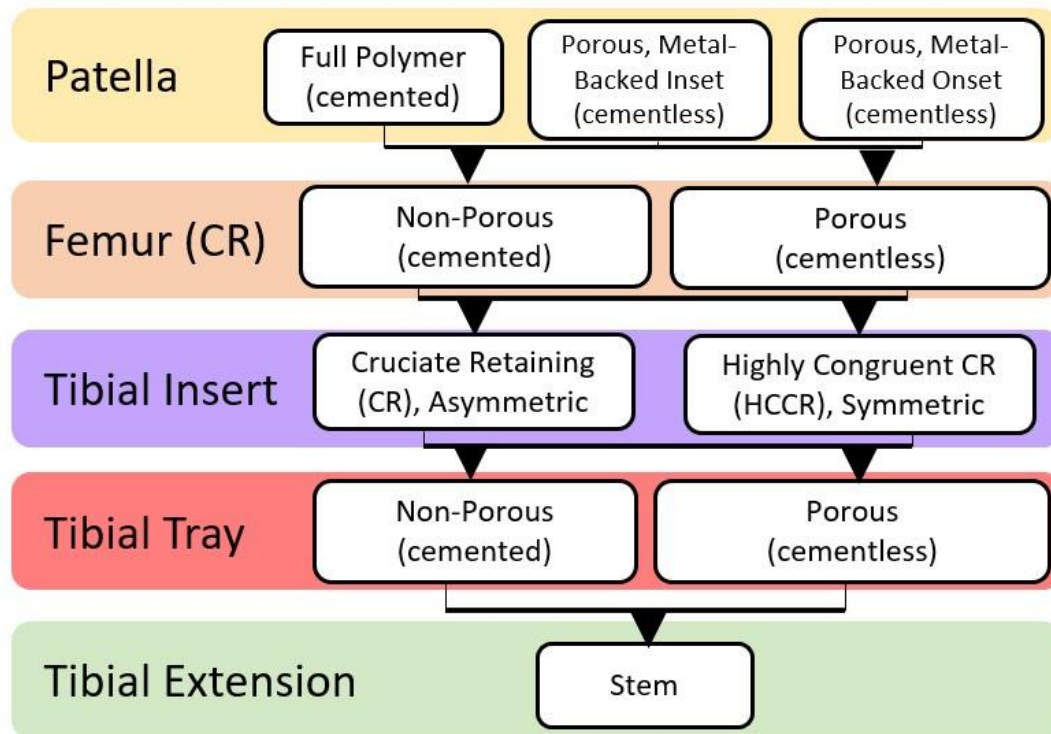

Figure 1. Optimotion™ Blue Total Knee System Options

Innovative instruments to assist with lateral approach. Optimotion™ Blue has unique instrument designs compatible with the standard medial parapatellar approach or the lateral subvastus approach to the knee. An **MCL Retractor** helps retract and shield the medial collateral ligament when the tibial bone cuts are made. An optional **Lateral Retractor Set** is available in an autoclavable tray containing short and regular versions of the MCL Retractor, two variations of forked Z-Retractors, and two variations of Meniscal Dissectors with detachable Modular Handles in two sizes to assist in the approach.

Optimotion Implants Blue Total Knee System

Surgical Technique Guide

Stemmed Tibial Tray. The Optimotion™ Blue **Tibial Trays** offer the ability to attach a wide variety of stem sizes (diameter and length) if extra stability is needed. The **Tibial Stem** can be added in both primary TKA and revision TKA situations.

System Compatibility

The system includes a broad range of sizes to fit the normal skeletally mature patient population. The system is designed so all of the left or right eight sizes of **Femoral Components** are interchangeable with a one size higher or one size lower **Tibial Tray** and **Tibial Insert** combination. The universally shaped **Tibial Tray** comes in eight sizes. The **CR Tibial Inserts** are offered in left and right bearing surface orientations and four thicknesses. The **HCCR Tibial Inserts** have a universally shaped articulating surface and are also offered in four thicknesses.

		Femoral Size							
		1	2	3	4	5	6	7	8
Insert Size	1	●	●						
	2	●	●	●					
	3		●	●	●				
	4			●	●	●			
	5				●	●	●		
	6					●	●	●	
	7						●	●	●
	8							●	●

Figure 2. Optimotion™ Blue CR Femoral and Insert Size Compatibility

Limb Positioning

With the patient lying in the supine position, ensure that the hip and knee can move freely and approximately 110° of knee flexion is able to be achieved.

Surgical Incision, Exposure, and Approaches

LATERAL APPROACH

When doing the lateral approach, the following sequence of steps must be followed in its entirety. On primary knees, initially preparing for an 11 mm versus a 9 mm tibial resection will make the procedure through this exposure simpler. The primary lateral incision is best made with the knee in flexion at 90 degrees.

1. Make an incision starting (A) about 5 cm proximal and 2.5cm lateral to the superolateral pole of the patella with the knee in the flexed position and carry the incision distally (B) along the edges of the patella tendon. Distally the incision traverses the interval between the patella tendon and Gerdy's Tubercle (Figure 3).



Figure 3.

2. Split the IT band proximally in line with the superficial incision and carry the incision over the lateral edge of the patella and the patella tendon to enter the joint.
3. Release the anterior horn of the lateral meniscus.
4. To further expose the lateral joint, use either a saw blade or an osteotome to osteotomize a sleeve of Gerdy's tubercle leaving approximately two (2) mm of bone thickness attached to the IT band where it inserts at Gerdy's tubercle.
5. Incise the capsular tissue between the tibial tuberosity and Gerdy's tubercle.
6. Elevate Gerdy's tubercle together with the IT band fibers to facilitate closure.
7. By elevating the distal IT band insertion on the tibia together with a thin wafer of bone, the IT band and tibialis anterior muscle become one longitudinal, continuous, stabilizing lateral ligament. This lateral ligament self-adjusts and reattaches to the anterolateral tibia after installation of the TKA components. Osteotomy of Gerdy's tubercle and posterior retraction of the IT band allow for excellent visualization to the lateral tibial plateau.
8. Cutting the Tibia: The knee is then brought into a semi-extended position of 15 to 30 degrees. The ACL is released at this point, as well as the anterior horn of the medial meniscus.

Optimotion Implants[®] Blue Total Knee System

Surgical Technique Guide

*This is an overview of steps for cutting the proximal tibia bone using the lateral approach. More details on the use of the instruments referred to in this section are in the **Tibial Preparation** section.*

9. The **MCL Retractor** (Figure 4) must be placed distal to the anterior horn of the medial meniscus and deep to the MCL to avoid cutting the MCL.



Figure 4. MCL Retractor

10. Guide the MCL Retractor around the posterior tibial plateau, ensuring the MCL Retractor is deep to and protecting the MCL during the resection process (Figure 5).

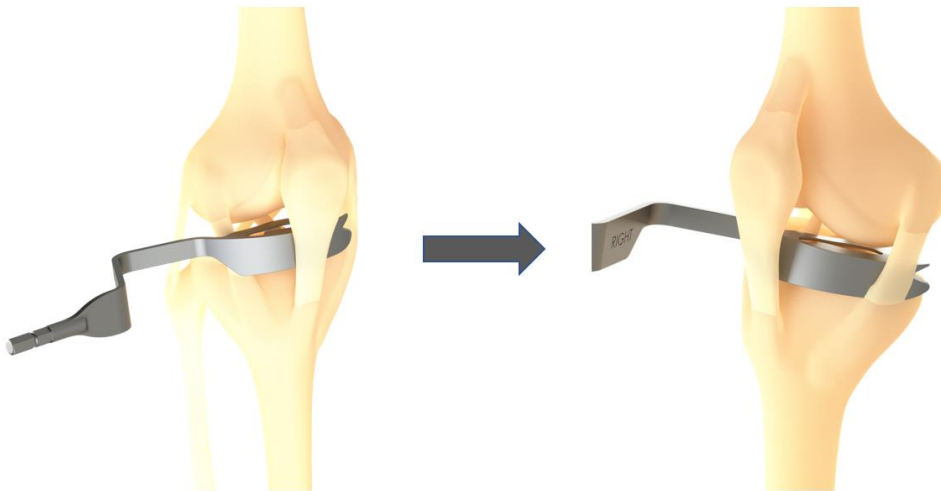

Figure 5. MCL Retractor Positioning

11. Place additional retractors by the PCL to sublax the tibia forward.

Optimotion Implants Blue Total Knee System

Surgical Technique Guide

12. Cut the lateral tibial plateau bone. Slide the cutting slot in the **Tibial Extramedullary Cutting Guide** medially to guide the saw blade to cut the rest of the tibia.
 - a. The resected tibial bone segments can then be removed after releasing the remaining posterior horns of both the menisci.
 - b. Gap balancing is done at this point at 0 and 90 degrees with either the **Dynamic Gap Balancing Gage** or the block **Gap Gages**.
13. There are two **Extramedullary Cutting Guide Proximal Rods**, one is set to 0°slope and the second to 3°slope according to surgeon preference.
14. Cutting the Patella: The patella is flipped 90 degrees to expose the articular surface. The **Patella Clamp** is applied, and the appropriate measuring stylus is used to determine patella resection. Slots on either side of the **Patella Clamp** allow for the patella cut to be made.

This is an overview of steps for preparing the femoral bone using the lateral approach, more details on the use of the instruments referred to in this section are shown in the [Femoral Preparation](#) section.

15. Place the retractors in the medial gutters and flex the knee to deliver the femur for preparation.
16. Once the femur cut is complete, bring the knee into extension and gently pull to expose the joint. Then carefully resect the medial meniscus with a sharp knife.
17. A PCL retractor and a conventional medial retractor are placed and the knee is slowly brought into flexion subluxing the tibia forward gently while displacing the lateral edge of the patella tendon medial to the medial tibial plateau. This will expose the tibial plateau for preparation.
18. The tibia preparation can then be finished and prepared as described in the **Tibial Preparation** section below.
19. Insertion of final components must be done in reverse as follows:
 - a. Insert the **Tibia Tray** component, with **Tibial Stem** attached (if needed).
 - b. Insert the **Tibial Insert**.
 - c. Insert the **Femoral Component**.
 - d. Insert the **Patella** implant.

MEDIAL APPROACH

A standard anterior mid-line incision can also be utilized with the Optimotion™ Blue Total Knee System.

1. If the medial parapatellar approach is selected, a straight midline skin incision, extending above and below the patella is applied to begin the exposure.
2. Any previous medial incision can be used or incorporated to decrease the risk of skin slough.
3. The capsular exposure is then approached by utilizing a longitudinal medial parapatellar incision, typically extending upward to a level of one third of the rectus femoris or vastus medians and downward to the medial side of the origin of patellar tendon on the tibial tuberosity.

Femoral Preparation

DISTAL FEMORAL CUT

Connect the **Femoral Drill** to the **Femoral IM Rod Handle** and establish an IM canal. The entry point is approximately one (1) cm anterior to the PCL attachment on the femur and slightly medial to the midline. Establish the IM canal with the **Femoral Drill** (Figure 6).

Attach the **Femoral IM Rod Handle** to the **Femoral IM Rod** and then slide the **Femoral Angular Alignment Guide** onto the **Femoral IM Rod** (Figure 7).

The **Femoral Angular Alignment Guide** is designed for either left or right knee and may be set to various varus/valgus cut angles 0-9 degrees on each side (Figure 8).

Pull back on the black knob of the **Femoral Angular Alignment Guide** and place it in the appropriate notch.



Figure 6



Figure 7

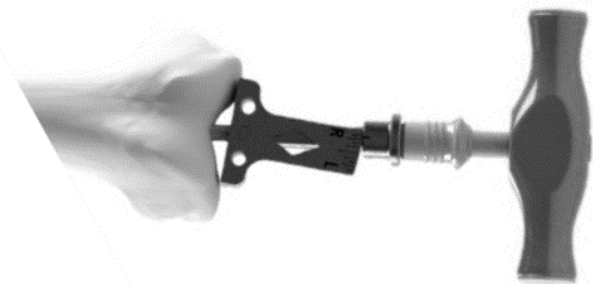

Figure 8

Optimotion Implants Blue Total Knee System

Surgical Technique Guide

The **Distal Femoral Cut Block** is attached to the **Distal Femoral Alignment Guide** and the assembly is attached to **Femoral Angular Alignment Guide**. The **Distal Femoral Alignment Guide** also allows for various femoral resection segments. Nine (9) mm is the default distal femoral resection, but by turning handle in the positive (+) or negative (-) direction the resection depth is adjustable from 4mm through 14mm. The **Femoral Angular Alignment Guide** must touch at least one of the femoral condyles to ensure adequate resection (Figure 9).

Once the desired valgus alignment and distal femoral resection is positioned the **Distal Femoral Cut Block** is secured with two 3.2mm Pins and an oblique 3.2 mm Pin. Then, the **Femoral Angular Alignment Guide**, **Distal Femoral Alignment Guide**, and the **Femoral IM Rod** are extracted. The **Distal Femoral Cut Block** can be also adjusted +2 mm by moving the guide to engage with 3.2mm Pins from the "0" parallel pin holes to the "+2" parallel pin holes (Figure 10).

The saw blade slot in the **Distal Femoral Cut Block** is meant for a 0.050 inch (1.33mm) thick saw blade.

Use a 1.33mm oscillating sawblade through the slots in the **Distal Femoral Cut Block** to cut the distal femur (Figure 11).



Figure 9



Figure 10

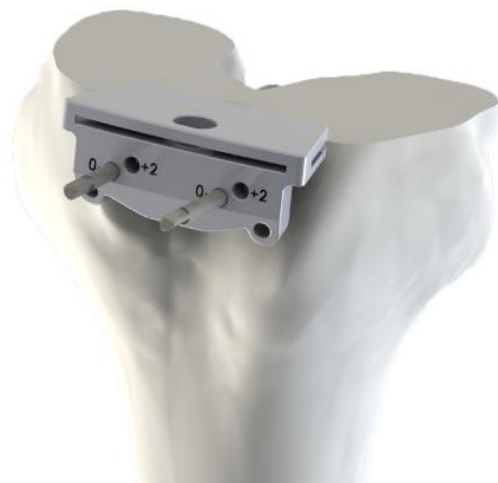

Figure 11

FEMORAL SIZING

The universal posterior referenced **Femoral Sizer** is applied to the distal femur with the two posterior condylar pads touching each posterior condyle in the femur (Figure 12).

The **Femoral Sizer** is a posterior referencing design. It is applied to the distal cut of the femur. The sizer is secured with one or two pins in two available holes above the **Femoral Sizer Disc**. Sizing is done with the **Stylus** touching the tip of the anterior lateral femur for the appropriate size of the femur implant. The size of the femur is read off of the slot on either side. If the size is between two numbers, then the size larger is used.

Using the **Femoral Sizer Disc**: The disc allows for increasing the flexion gap 0mm, -1mm, -2mm, or decreasing the flexion gap +1 or +2mm relative to the measured size. Identify the flexion gap desired first. Set the gap with the arrow to the desired rotation for the **Femoral Chamfer Cut Block**. Up to 7 degrees of rotation can be performed either way. Secure the rotation of the **Femoral Sizer Disc** by tightening the **Knob** to prevent rotation of the sizer disc during drilling.

Once rotation and any adjustments to posterior resection are made, then two drill holes are made through the **Femoral Sizer** to fit the **Femoral Chamfer Cut Block** (Figure 13). Make sure the pin 3.2 mm drills through the correct numbered flexion gap holes (see fig or animation). For example, if the desired flexion gap is 0 then drill for the universal cut block holes through the holes marked 0.

Remove the **Femoral Sizer** and apply the appropriate **Femoral Chamfer Cut Block**.

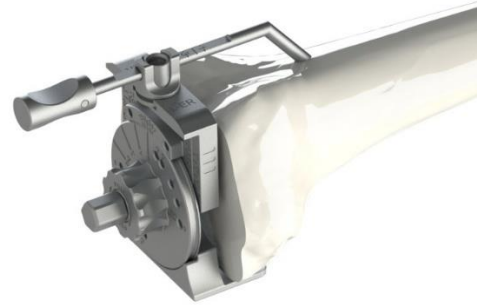

Figure 12



Figure 13

FEMORAL CUT BLOCK

Once the parallel pegs in the appropriate sized **Femoral Chamfer Cut Block** are aligned with the drilled holes above, the **Femoral Chamfer Cut Block** is impacted into place against the distal femoral cut surface with a Mallet (Figure 14).

Use the **Angel Wing**, or an equivalent Blade sizer or “batwing” (Figure 15) to double check the potential run-out of the anterior resection cut to prevent notching of the anterior femur.

The **Femoral Chamfer Cut Block** is secured with two converging 3.2mm Pins once the block is flush with the distal femur (Figure 16).

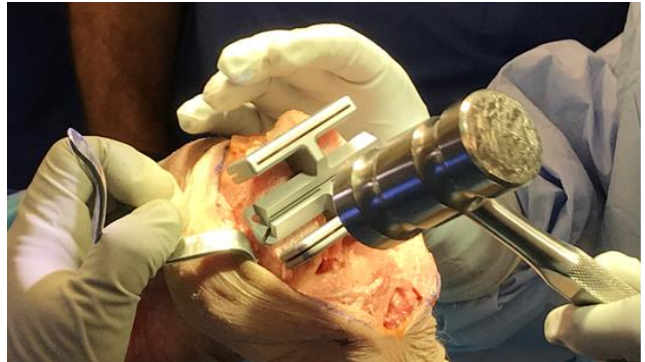

Figure 14



Figure 15

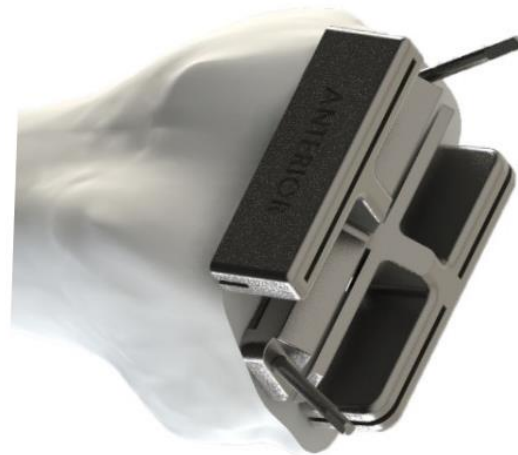

Figure 16

Optimotion Implants Blue Total Knee System

Surgical Technique Guide

Use a 1.33mm oscillating sawblade through the slots in the **Femoral Chamfer Cut Block** to cut the anterior, posterior, anterior chamfer, posterior chamfer cuts in the distal femur (Figure 17). The thickness of the sawblade is important to ensure the cuts are well controlled via the guide slots throughout the procedure.

The 3.2mm Pins are removed, the **Femoral Chamfer Cut Block** is removed, and the resected bone segments are then extracted.

The **Curved Osteotome** can then be used to remove the excessive osteophytes in the posterior femoral condyles (Figure 18).

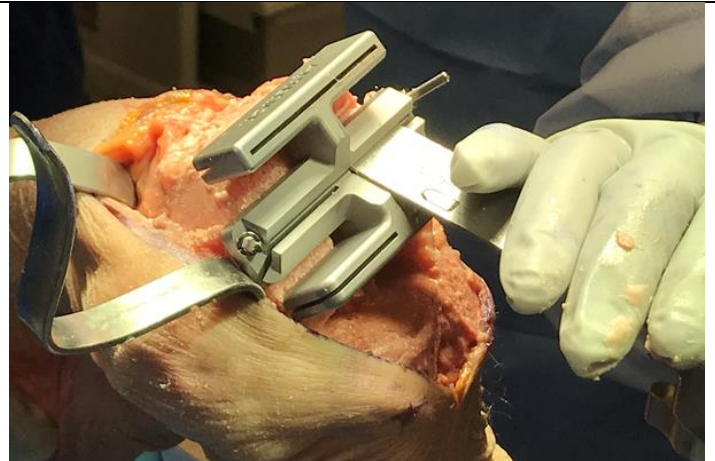

Figure 17

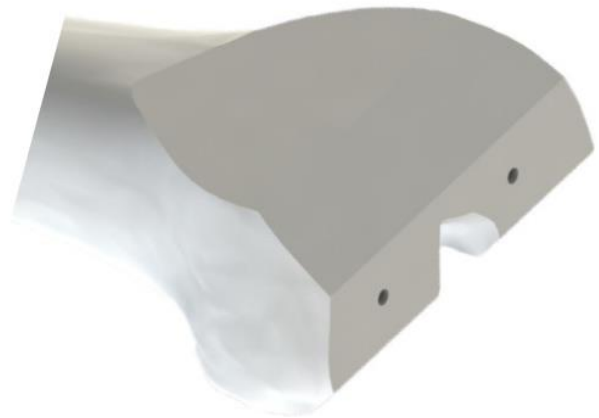

Figure 18

FEMORAL PREPARATION

Once the femoral size has been established a **Universal Femoral Trial** is attached to the **Femoral Impactor** (Figure 19) and impacted into place.

The **Femoral Trial** can be used for either left or right femurs and for range of motion trialing on CR or HCCR **Tibial Insert Trials**.

Drill holes in the distal femoral bone with the **Patella Drill** through the holes in the **Femoral Trial** to establish the location of the **Femoral Component** peg holes (Figure 20).

After the appropriately sized **Tibial Tray Template**, **Tibial Insert Trial**, and **Patella Trial** are in place later in the procedure, the **Femoral Trial** will be re-attached to the femur to assess the range of motion, the tibiofemoral articulation, and the patella tracking (Figure 21).



Figure 19

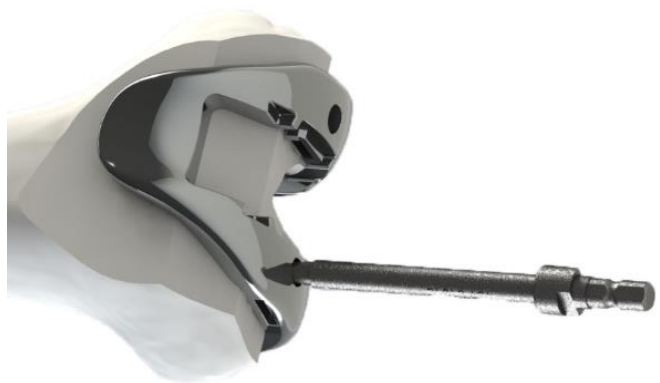

Figure 20



Figure 21

CR FEMORAL COMPONENT

If a **CR Femoral Component** is used with bone cement, apply bone cement to the distal femoral cuts and insert the **CR Femoral Component** using the **Femoral Impactor** (Figure 22A).

If a porous **Uncemented CR Femoral Component** is used without bone cement, do not apply bone cement, and insert the **Femoral Component** using the **Femoral Impactor**. A **Femoral Driver with Impactor Handle** may be used optionally to impact and complete placement of **Uncemented CR Femoral Component** (Figure 22B).

The **Femoral Impactor** is also used to remove the **Femoral Component** when needed. To remove the **Femoral Component**, first loosen the **Femoral Component** from the bone with an osteotome, then connect the side tabs in the **Femoral Impactor** in the slots in the sides of the **Femoral Component** and tighten down the tightening knob to secure the **Femoral Impactor** (Figure 22A). Apply extraction force to the **Femoral Impactor** to remove the **Femoral Component** from the bone. The back side of the strike head of the **Femoral Impactor** can be impacted with a mallet to assist in the **Femoral Component** removal.

If additional extraction force is needed, the **Slap Hammer** can be used with the **Femoral Impactor**. Thread the **Femoral Impactor-Slap Hammer Adapter** onto the end of the **Slap Hammer** and into the **Femoral Impactor**. With the **Femoral Impactor** engaged with the **Femoral Implant Component**, swiftly slide the handle of the **Slap Hammer** along the shaft to apply force to dislodge the implant (Figure 23).



Figure 22



Figure 23

Tibial Resection and Bone Preparation

TIBIAL CUT GUIDE ALIGNMENT

The Optimotion™ Blue tibial resection is aligned by using extramedullary alignment with the aid of the **Extramedullary Guide (EM Guide)**.

Assemble the **EM Guide**, the **EM Guide-Resection Guide Connector**, and the **Tibial Resection Guide** (Figure 24).

The **EM Guide-Resection Guide Connector** has 0° and 3° slopes. The **EM Guide** is in the neutral position when the **EM Guide-Resection Guide Connector** is parallel to the long axis of the tibial bone.

The **Tibial Resection Guide** is universal and can be attached for left or right knees. The **Tibial Stylus** (4mm-9mm OR 2mm-11mm) is re-attachable and can be placed on the medial or the lateral side of the **Tibial Resection Guide** (Figure 25).

Center the Ankle Clamp of the **EM Guide** over the center of the ankle. This is usually the second metatarsal.

Adjustments can be made at the Ankle Clamp of the **EM Guide** to adjust for slope or the varus-valgus tilt by unlocking the adjustment screw and tightening the adjustment screws in the Ankle Clamp (Figure 26).

The **Tibial Stylus** can alternate between the medial or lateral connecting post on the **Tibial**



Figure 24

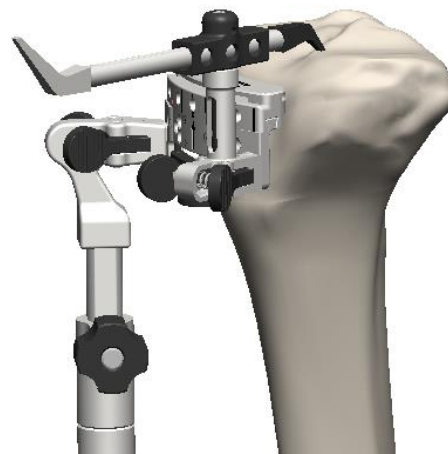

Figure 25

Optimotion Implants Blue Total Knee System

Surgical Technique Guide

Resection Guide by releasing the connecting clamp. For a **9mm Tibial Insert** adjust to the following:

- 9mm resection over the lowest point of the unaffected side
- 2mm resection over the lowest point of the affected side

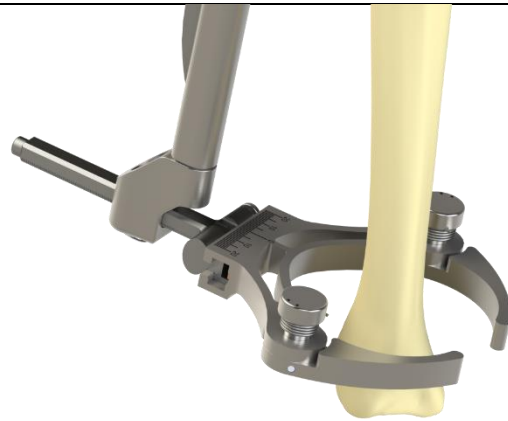

Figure 26

TIBIAL RESECTION

Pin the **Tibial Resection Guide** with two 3.2mm pins (Figure 27).

The upper slot of the **Tibial Resection Guide** can be swiveled left or right by depressing the lower lever to obtain the best **Tibial Resection Guide** orientation for the saw blade and alternatively pinned for additional stability (Figure 28).

- Use a 1.33mm saw to cut the tibia through the slot in the **Tibial Resection Guide** (Figure 29).
- Remove the **Tibial Resection Guide**.
- The resected tibial bone segment can then be removed after releasing the remaining posterior horns of both menisci.

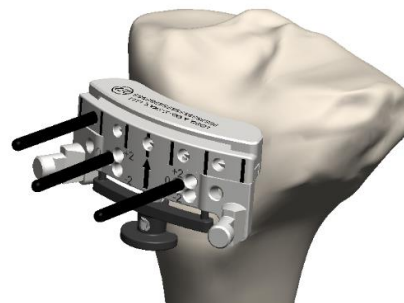

Figure 27

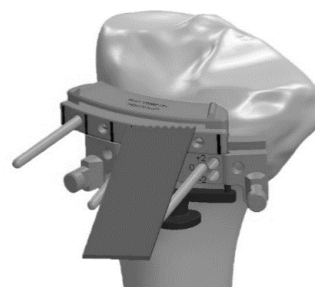

Figure 28

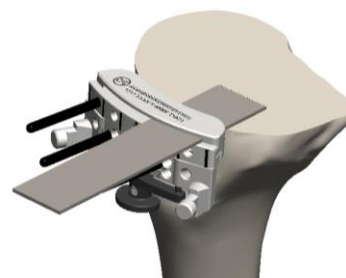

Figure 29

GAP BALANCING

After cutting the distal femur and proximal tibia, trim any osteophytes and assess the initial ligament balance and extension gap. With the leg in extension, position the **Dynamic Gap Balancing Gage** in the extension gap and adjust the gage (Figure 30).

With the **Dynamic Gap Balancing Gage** in place, the extension gap should be rectangular when the ligaments are equally tensioned and balanced. The plates on the **Dynamic Gap Balancing Gage** are adjusted by rotating the knob to different heights 9 to 19mm.

The measurement on this **Dynamic Gap Balancing Gauge** is in millimeters. The measurement represents the polymer **Tibial Insert** thickness in millimeters needed to produce the same extension gap balance and tension. It is the measurement from the distal resected surface of the Femur to Proximal resected surface of the Tibia minus the **Tibial Tray** and the **Femoral Component**. The plates on the **Dynamic Gap Balancing Gage** show the imbalance of the ligaments.

When the extension gap is unbalanced an angular alignment indicator will displace to the side of imbalance up to 5 degrees. Additional resection, either bony or soft tissue releases, can be performed to achieve extension gap balance. Adjust the ligaments to make the indicator read 0. Alternatively, the surgeon may choose to lock the dynamic gap gage to not allow for any angular displacement. The knee is then brought into flexion to confirm equal flexion and extension gap balance.

A 'two-sided spacer style' **Gap Gage** (Figure 31) can also be used alternatively to assess ligament balance and extension gap. The numerical reading on each side of this gap gage represents the polymer Tibial Insert thickness needed to produce the same extension gap balance and tension.



Figure 30

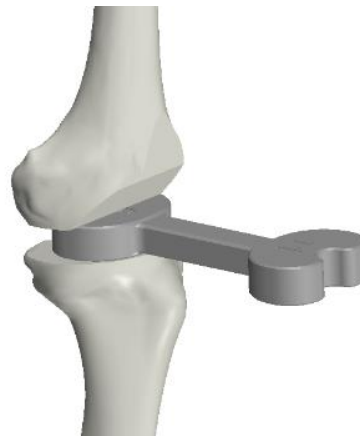

Figure 31

TIBIAL SIZING

The different sizes of the universal **Tibial Tray Templates**, and **Tibial Insert Trials** are designed to be used to perform trial reduction and assess overall fit.

The medial to lateral length as well as the anterior to posterior length of the **Tibial Tray** should match as closely as possible to the medial to lateral length and the anterior to posterior length of the remaining tibial bone. Under sizing the **Tibial Tray** can result in catastrophic settling and oversizing can result in rim avulsion fractures of the tibia.

The **Tibial Tray Templates** are universal for left or right knees. They can be connected to the **Tibial Template Handle** by pressing the button on the **Tibial Template Handle** and sliding the parallel post on the **Tibial Template Handle** into the parallel holes in the **Tibial Tray Template**.

Once rotation and position of the **Tibial Tray Template** is determined, the **Tibial Tray Template** is pinned with two anterior oblique **3.2 Headed Pins** or alternatively with **3.2 Headed Pins** in the superior pin slots on the **Tibial Tray Template** (Figure 32).

The **Keel Punch Guide** is snapped into place on the **Tibial Tray Template** (Figure 33).

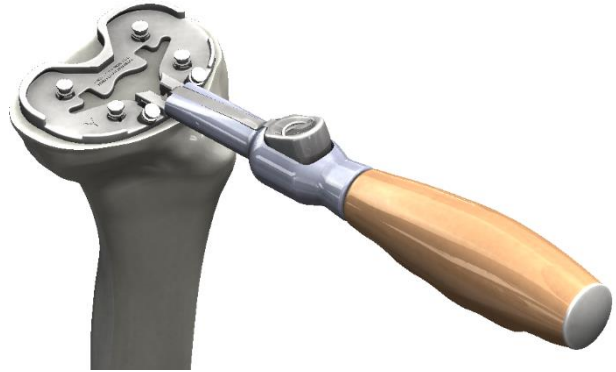

Figure 32

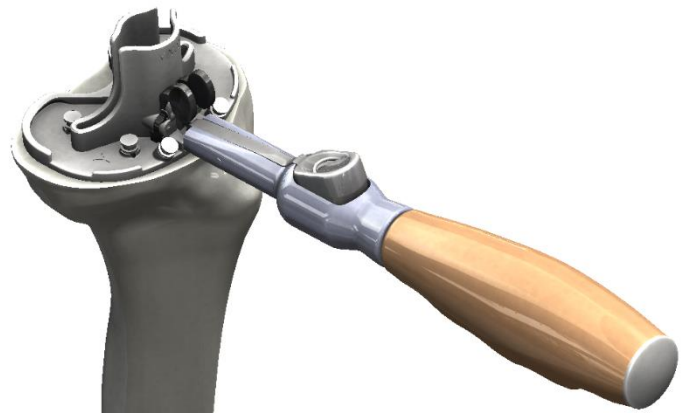

Figure 33

Optimotion Implants Blue Total Knee System

Surgical Technique Guide

The **Tibial Template Handle** can be removed. Using the **Central Drill (16mm or 17mm)**, drill through the **Keel Punch Guide** and the **Tibial Tray Template** until it bottoms out (Figure 34A) on the **Keel Punch Guide**. This hole is made in the tibial bone to establish the center of the **Tibial Tray** keel.

The **Central Drill** is offered in two diameters 16mm and 17mm. Use the 16mm Central Drill if implanting a Porous **Tibial Tray** and 17mm if cementing the **Tibial Tray**.

There are three **Keel Punches** for various sizes.

SMALL – Sizes 1-3

MEDIUM – Sizes 4-6

LARGE – Sizes 7-8

Use a mallet to impact the appropriate size **Keel Punch** down to prepare the bone for the keel fins on the **Tibial Tray** until the **Keel Punch** bottoms out at the top of the **Keel Punch Guide** (Figure 34B).

When using the porous component, remove the **Keel Punch Guide Assembly** and then prepare the tibial bone for the **Tibial Tray** Pegs. One at a time, extract the **Headed Pins** with the **Pin Puller** (Figure 35), or a similar pin extractor.

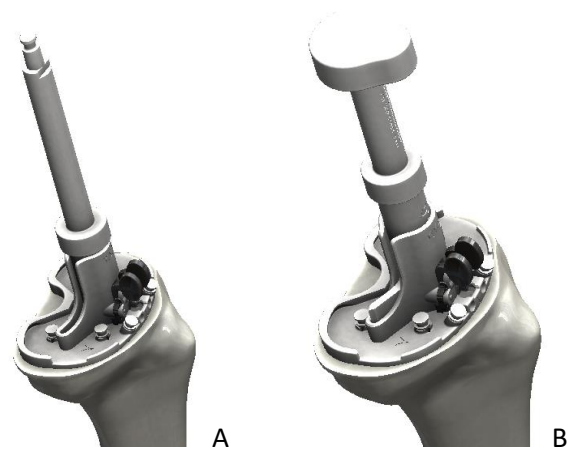

Figure 34



Figure 35

Then use the **Tibial Tray Peg Punch** to prepare the **Tibial Tray** peg shape in the bone, through the superior pin holes in the **Tibial Tray Template** (Figure 36).

There are only two posterior pegs for sizes 1-3. There are 4 pegs for sizes 4-8.

If surgeon opts to use the **Tibial Insert Trials**, the **Keel Punch Guide Assembly** needs to be removed, if it has not already been removed.

The appropriate **Tibial Insert Trial** is inserted on the **Tibial Tray Template** to assess fit, joint laxity, and range of motion. The **Tibial Insert Trial 6mm Shim** can be used to add 6mm more to **Tibial Insert Trial** height (Figure 37).

See suggestions in the **Knee Balancing Algorithm** section if further balancing is needed.

Once the appropriate **Tibial Insert** thickness and the amount of tibial resection is found to be appropriate, the **Headed Pins** should be removed from the **Tibial Insert Trial** and all remaining tibial instrumentation removed in preparation for the placement of the **Tibial Tray Implant**.

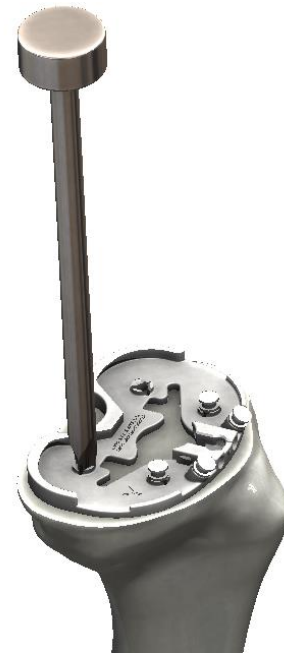

Figure 36

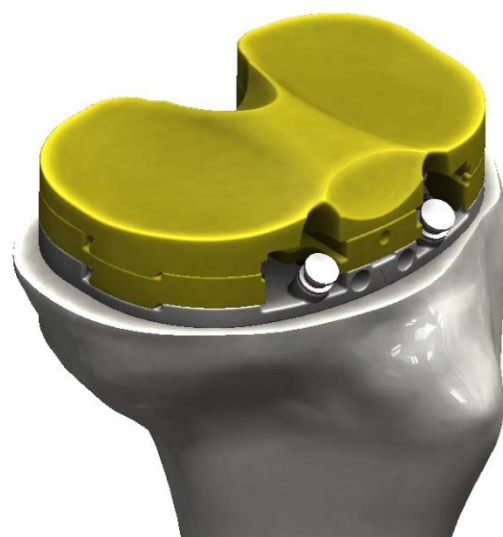

Figure 37

TIBIAL TRAY IMPLANTATION

Connect the **Tibial Tray Impactor** to the **Impactor Handle**. Then, deliver the Uncemented **Tibial Tray** onto the prepared tibia bone and impact until the baseplate of the Uncemented **Tibial Tray** is seated with minimal gaps between the Porous **Tibial Tray** and the cut proximal tibia.

If a cemented **Tibial Tray** is used, place bone cement between the cemented **Tibial Tray** and the cut proximal tibia prior to implant delivery. Once the **Tibial Tray** is seated, clear all excess bone cement surrounding the periphery of the **Tibial Tray** (Figure 38).



Figure 38

TIBIAL TRAY REMOVAL

To extract the **Tibial Tray**, first loosen the **Tibial Tray** with an osteotome, and then extract using a Mallet and an osteotome.

If additional extraction force is needed, the **Slap Hammer** can be used. Attach the **Tibial Tray Extractor** to the **Tibial Tray** by sliding it into the dovetail feature and aligning the peg on the **Tibial Tray Extractor** with the hole in the **Tibial Tray** (Figure 39). Lock into place with the **3.5MM Hex Driver** (Figure 40). Attach the **Slap Hammer** to the **Tibial Tray Extractor** using the threaded connection. Extract the **Tibial Tray** by swiftly sliding the handle of the **Slap Hammer** upwards (Figure 41).



Figure 39



Figure 40

TIBIAL INSERT IMPLANTATION

Engage the **Tibial Insert** with the **Tibial Tray** by placing it slightly angled while adjusting it posteriorly and distally until it snaps into the **Tibial Tray**. This can be done with the assistance of the **Tibial Insert Impactor** (Figure 42).

The **Tibial Insert** is fully seated when the polymer tab on its distal side is locked under the anterior catch on the **Tibial Tray**.

TIBIAL INSERT REMOVAL

To extract the **Tibial Insert**, place a 1/8 inch, or similarly sized, osteotome in the front tab on the **Tibial Insert** and twist the osteotome until the polymer **Tibial Insert** is loosened and disengages from the **Tibial Tray**. The **Tibial Insert** cannot be reused.



Figure 41



Figure 42

TIBIAL STEMS

The optional **Tibial Stems** are meant to fit in either **Cementless Tibial Trays** or **Cemented Tibial Trays** (Figure 43).

The **Tibial Stem** and the **Tibial Tray** are locked together by a tapered connection secured with a set screw. Tibial Stem assembly should be performed on a solid, fully supported table by turning the **Tibial Tray** upside down on a soft cloth and attaching the intended **Tibial Stem**. Apply a second soft cloth over the **Tibial Stem** and impact the two components together with in-line impaction from a mallet. Two to three forceful blows with a mallet should be used to lock the tapered connection between the **Tibial Stem** and the **Tibial Tray** together.

Use the **2.5mm Hex Driver** to transfer the 2 **Taper Set Screws** to the anterior and posterior holes in the **Tibial Tray** keel. Use the Hex Driver to tighten the Taper Set Screw into the grooves of the **Tibial Stem** to secure the connection between the Tibial Stem and Tibial Tray (Figure 44).



Figure 43



Figure 44

Optimotion Implants Blue Total Knee System Surgical Technique Guide

The **Tibial Stem** can be placed into the bone after first reaming the tibial bone with the appropriately sized straight reamer. For uncemented Tibial Stems, match the reamer to the stem diameter. For cemented use, use a reamer 1mm larger than the Tibial Stem.

After the **Tibial Keel Punch** is used, place the appropriate sized **Tibial Stem Drill Bushing** into the **Keel Punch Guide** (Figure 45). Using the appropriate sized **Tibial Stem Drill**, ream the bone until the bottom of the appropriate marking reaches the top of the **Tibial Stem Drill Bushing** (Figure 46). The markings represent the available lengths of **Tibial Stem** (25MM, 50MM, 75MM, 115MM, and 150MM), shown in Figure 47.



Figure 45



Figure 46

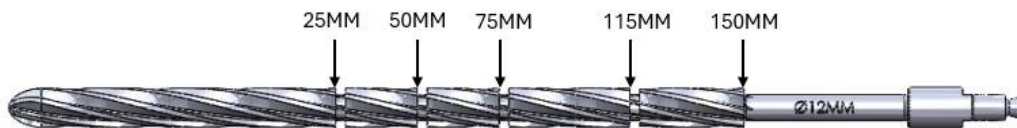

Figure 47

Patellar Preparation

PATELLAR RESECTION AND TRIALS

The **Patella Clamp** is a common parallel pivoting mechanism style instrument often used for patella implant preparation. The **Patella Clamp** has universal style connections on both arms allowing the **Patella Resection Guides**, **Patella Drill Guide**, and **Patella Cement Clamps** to snap in place (Figure 48).

Use the **Patella Resection Guides** with the **Patella Stylus** to determine the measured resection, 9mm or 10 mm from the patella apex of the cartilage side of the patella (Figure 49).

Exchange the **Patella Resection Guide** for the **Patella Drill Guide** (with three drill holes) to the appropriate position and drill three holes for the **Patella** implant (Figure 50).



Figure 48



Figure 49



Figure 50

Patella Sizers can be attached to the **Patella Drill Guide** (31mm diameter) to size a 33, 36, or 39mm patella (Figure 51).

Insert the **Patella Trial** components to trial all components to determine patella tracking (Figure 52).

Prepare the resected bone surfaces for bone cement application. Apply the bone cement between the resected patella and the **Patella** implant. Clamp the **Patella** implant with **Patella Clamps (Anterior and Posterior)** and hold it in place while the bone cement hardens (Figure 53).



Figure 51



Figure 52



Figure 53

Knee Balancing Algorithm

The ligament balance of the knee should be verified in flexion and extension. If balance has not been achieved, the following suggested steps outlined in the table below may be of assistance.

Extension	Flexion	Method
Acceptable	Acceptable	Proceed to next step.
Tight	Acceptable	Release posterior capsule and/or re-cut the distal femur using +2mm on the Distal Femoral Cut Block and recut with the femoral cuts with same size Femoral Chamfer Cut Block .
Loose	Acceptable	Increase the slope of the tibial cut using the Tibial Resection Guide and upsize the thickness of the polymer Tibial Insert .
Acceptable	Too Tight	<ol style="list-style-type: none"> 1. Increase the slope cut of the tibia using the Tibial Resection Guide. 2. Recess the PCL. 3. Downsize the Femoral Component (provided no notching occurs) using one size smaller Femoral Chamfer Cut Block.
Acceptable	Too Loose	Recut the distal femur and increase the thickness of the polymer Tibial Insert .
Too Tight	Too Tight	Downsize the polymer Tibial Insert if possible, OR recut the tibia using the Tibial Resection Guide .
Too Loose	Too Tight	Recut the tibia to add more posterior slope then upsize the Tibial Insert OR down size Femoral Component and upsize the Tibial Insert .
Too Loose	Too Loose	Upsize the thickness of the polymer Tibial Insert .

Implant Product List

FEMORAL COMPONENTS

Catalog Number	Catalog Description
1014-F-0101	CR Femoral Component, Non-Porous CoCr, CEMENTED, Size 1, Left
1014-F-0102	CR Femoral Component, Non-Porous CoCr, CEMENTED, Size 1, Right
1014-F-0201	CR Femoral Component, Non-Porous CoCr, CEMENTED, Size 2, Left
1014-F-0202	CR Femoral Component, Non-Porous CoCr, CEMENTED, Size 2, Right
1014-F-0301	CR Femoral Component, Non-Porous CoCr, CEMENTED, Size 3, Left
1014-F-0302	CR Femoral Component, Non-Porous CoCr, CEMENTED, Size 3, Right
1014-F-0401	CR Femoral Component, Non-Porous CoCr, CEMENTED, Size 4, Left
1014-F-0402	CR Femoral Component, Non-Porous CoCr, CEMENTED, Size 4, Right
1014-F-0501	CR Femoral Component, Non-Porous CoCr, CEMENTED, Size 5, Left
1014-F-0502	CR Femoral Component, Non-Porous CoCr, CEMENTED, Size 5, Right
1014-F-0601	CR Femoral Component, Non-Porous CoCr, CEMENTED, Size 6, Left
1014-F-0602	CR Femoral Component, Non-Porous CoCr, CEMENTED, Size 6, Right
1014-F-0701	CR Femoral Component, Non-Porous CoCr, CEMENTED, Size 7, Left
1014-F-0702	CR Femoral Component, Non-Porous CoCr, CEMENTED, Size 7, Right
1014-F-0801	CR Femoral Component, Non-Porous CoCr, CEMENTED, Size 8, Left
1014-F-0802	CR Femoral Component, Non-Porous CoCr, CEMENTED, Size 8, Right
1014-F-4101	CR Femoral Component, Porous CoCr, Size 1, Left
1014-F-4102	CR Femoral Component, Porous CoCr, Size 1, Right
1014-F-4201	CR Femoral Component, Porous CoCr, Size 2, Left
1014-F-4202	CR Femoral Component, Porous CoCr, Size 2, Right
1014-F-4301	CR Femoral Component, Porous CoCr, Size 3, Left
1014-F-4302	CR Femoral Component, Porous CoCr, Size 3, Right
1014-F-4401	CR Femoral Component, Porous CoCr, Size 4, Left
1014-F-4402	CR Femoral Component, Porous CoCr, Size 4, Right
1014-F-4501	CR Femoral Component, Porous CoCr, Size 5, Left
1014-F-4502	CR Femoral Component, Porous CoCr, Size 5, Right
1014-F-4601	CR Femoral Component, Porous CoCr, Size 6, Left
1014-F-4602	CR Femoral Component, Porous CoCr, Size 6, Right
1014-F-4701	CR Femoral Component, Porous CoCr, Size 7, Left
1014-F-4702	CR Femoral Component, Porous CoCr, Size 7, Right
1014-F-4801	CR Femoral Component, Porous CoCr, Size 8, Left
1014-F-4802	CR Femoral Component, Porous CoCr, Size 8, Right

TIBIAL COMPONENTS

Catalog Number	Catalog Description
1014-B-9000	TAPER SET SCREW
1014-B-0100	Tibial Tray Component, Non-Porous Titanium, CEMENTED, Size 1
1014-B-0200	Tibial Tray Component, Non-Porous Titanium, CEMENTED, Size 2
1014-B-0300	Tibial Tray Component, Non-Porous Titanium, CEMENTED, Size 3
1014-B-0400	Tibial Tray Component, Non-Porous Titanium, CEMENTED, Size 4
1014-B-0500	Tibial Tray Component, Non-Porous Titanium, CEMENTED, Size 5
1014-B-0600	Tibial Tray Component, Non-Porous Titanium, CEMENTED, Size 6
1014-B-0700	Tibial Tray Component, Non-Porous Titanium, CEMENTED, Size 7
1014-B-0800	Tibial Tray Component, Non-Porous Titanium, CEMENTED, Size 8
1014-B-1100	Tibial Tray Component, Porous Titanium, Size 1
1014-B-1200	Tibial Tray Component, Porous Titanium, Size 2
1014-B-1300	Tibial Tray Component, Porous Titanium, Size 3
1014-B-1400	Tibial Tray Component, Porous Titanium, Size 4
1014-B-1500	Tibial Tray Component, Porous Titanium, Size 5
1014-B-1600	Tibial Tray Component, Porous Titanium, Size 6
1014-B-1700	Tibial Tray Component, Porous Titanium, Size 7
1014-B-1800	Tibial Tray Component, Porous Titanium, Size 8

TIBIAL STEMS

Catalog Number	Catalog Description
1014-S-1000	STEM ϕ 10X25MM
1014-S-1005	STEM ϕ 10X75MM
1014-S-1015	STEM ϕ 10X115MM
1014-S-1050	STEM ϕ 10X150MM
1014-S-1055	STEM ϕ 10X50MM
1014-S-1200	STEM ϕ 12X25MM
1014-S-1205	STEM ϕ 12X75MM
1014-S-1215	STEM ϕ 12X115MM
1014-S-1250	STEM ϕ 12X150MM
1014-S-1255	STEM ϕ 12X50MM
1014-S-1400	STEM ϕ 14X25MM
1014-S-1405	STEM ϕ 14X75MM
1014-S-1415	STEM ϕ 14X115MM
1014-S-1450	STEM ϕ 14X150MM
1014-S-1455	STEM ϕ 14X50MM

1014-S-1605	STEM ϕ 16X75MM
1014-S-1615	STEM ϕ 16x115mm
1014-S-1650	STEM ϕ 16x150mm
1014-S-1805	STEM ϕ 18X75MM
1014-S-1815	STEM ϕ 18X115MM
1014-S-1850	STEM ϕ 18x150mm
1014-S-2005	STEM ϕ 20x75mm
1014-S-2015	STEM ϕ 20x115mm
1014-S-2050	STEM ϕ 20x150mm
1014-S-2205	STEM ϕ 22x75mm
1014-S-2215	STEM ϕ 22x115mm
1014-S-2250	STEM ϕ 22x150mm

CR ASSYMETRIC TIBIAL INSERTS

Catalog Number	Catalog Description
1014-P-0109-01	CR Tibial Insert, UHMWPE with Vitamin E, Size 1, Thickness 9mm, Left
1014-P-0109-02	CR Tibial Insert, UHMWPE with Vitamin E, Size 1, Thickness 9mm, Right
1014-P-0110-01	CR Tibial Insert, UHMWPE with Vitamin E, Size 1, Thickness 10mm, Left
1014-P-0110-02	CR Tibial Insert, UHMWPE with Vitamin E, Size 1, Thickness 10mm, Right
1014-P-0111-01	CR Tibial Insert, UHMWPE with Vitamin E, Size 1, Thickness 11mm, Left
1014-P-0111-02	CR Tibial Insert, UHMWPE with Vitamin E, Size 1, Thickness 11mm, Right
1014-P-0112-01	CR Tibial Insert, UHMWPE with Vitamin E, Size 1, Thickness 12mm, Left
1014-P-0112-02	CR Tibial Insert, UHMWPE with Vitamin E, Size 1, Thickness 12mm, Right
1014-P-0113-01	CR Tibial Insert, UHMWPE with Vitamin E, Size 1, Thickness 13mm, Left
1014-P-0113-02	CR Tibial Insert, UHMWPE with Vitamin E, Size 1, Thickness 13mm, Right
1014-P-0114-01	CR Tibial Insert, UHMWPE with Vitamin E, Size 1, Thickness 14mm, Left
1014-P-0114-02	CR Tibial Insert, UHMWPE with Vitamin E, Size 1, Thickness 14mm, Right
1014-P-0115-01	CR Tibial Insert, UHMWPE with Vitamin E, Size 1, Thickness 15mm, Left
1014-P-0115-02	CR Tibial Insert, UHMWPE with Vitamin E, Size 1, Thickness 15mm, Right
1014-P-0116-01	CR Tibial Insert, UHMWPE with Vitamin E, Size 1, Thickness 16mm, Left
1014-P-0116-02	CR Tibial Insert, UHMWPE with Vitamin E, Size 1, Thickness 16mm, Right
1014-P-0117-01	CR Tibial Insert, UHMWPE with Vitamin E, Size 1, Thickness 17mm, Left
1014-P-0117-02	CR Tibial Insert, UHMWPE with Vitamin E, Size 1, Thickness 17mm, Right
1014-P-0118-01	CR Tibial Insert, UHMWPE with Vitamin E, Size 1, Thickness 18mm, Left
1014-P-0118-02	CR Tibial Insert, UHMWPE with Vitamin E, Size 1, Thickness 18mm, Right
1014-P-0119-01	CR Tibial Insert, UHMWPE with Vitamin E, Size 1, Thickness 19mm, Left
1014-P-0119-02	CR Tibial Insert, UHMWPE with Vitamin E, Size 1, Thickness 19mm, Right
1014-P-0209-01	CR Tibial Insert, UHMWPE with Vitamin E, Size 2, Thickness 9mm, Left
1014-P-0209-02	CR Tibial Insert, UHMWPE with Vitamin E, Size 2, Thickness 9mm, Right

Catalog Number	Catalog Description
1014-P-0210-01	CR Tibial Insert, UHMWPE with Vitamin E, Size 2, Thickness 10mm, Left
1014-P-0210-02	CR Tibial Insert, UHMWPE with Vitamin E, Size 2, Thickness 10mm, Right
1014-P-0211-01	CR Tibial Insert, UHMWPE with Vitamin E, Size 2, Thickness 11mm, Left
1014-P-0211-02	CR Tibial Insert, UHMWPE with Vitamin E, Size 2, Thickness 11mm, Right
1014-P-0212-01	CR Tibial Insert, UHMWPE with Vitamin E, Size 2, Thickness 12mm, Left
1014-P-0212-02	CR Tibial Insert, UHMWPE with Vitamin E, Size 2, Thickness 12mm, Right
1014-P-0213-01	CR Tibial Insert, UHMWPE with Vitamin E, Size 2, Thickness 13mm, Left
1014-P-0213-02	CR Tibial Insert, UHMWPE with Vitamin E, Size 2, Thickness 13mm, Right
1014-P-0214-01	CR Tibial Insert, UHMWPE with Vitamin E, Size 2, Thickness 14mm, Left
1014-P-0214-02	CR Tibial Insert, UHMWPE with Vitamin E, Size 2, Thickness 14mm, Right
1014-P-0215-01	CR Tibial Insert, UHMWPE with Vitamin E, Size 2, Thickness 15mm, Left
1014-P-0215-02	CR Tibial Insert, UHMWPE with Vitamin E, Size 2, Thickness 15mm, Right
1014-P-0216-01	CR Tibial Insert, UHMWPE with Vitamin E, Size 2, Thickness 16mm, Left
1014-P-0216-02	CR Tibial Insert, UHMWPE with Vitamin E, Size 2, Thickness 16mm, Right
1014-P-0217-01	CR Tibial Insert, UHMWPE with Vitamin E, Size 2, Thickness 17mm, Left
1014-P-0217-02	CR Tibial Insert, UHMWPE with Vitamin E, Size 2, Thickness 17mm, Right
1014-P-0218-01	CR Tibial Insert, UHMWPE with Vitamin E, Size 2, Thickness 18mm, Left
1014-P-0218-02	CR Tibial Insert, UHMWPE with Vitamin E, Size 2, Thickness 18mm, Right
1014-P-0219-01	CR Tibial Insert, UHMWPE with Vitamin E, Size 2, Thickness 19mm, Left
1014-P-0219-02	CR Tibial Insert, UHMWPE with Vitamin E, Size 2, Thickness 19mm, Right
1014-P-0309-01	CR Tibial Insert, UHMWPE with Vitamin E, Size 3, Thickness 9mm, Left
1014-P-0309-02	CR Tibial Insert, UHMWPE with Vitamin E, Size 3, Thickness 9mm, Right
1014-P-0310-01	CR Tibial Insert, UHMWPE with Vitamin E, Size 3, Thickness 10mm, Left
1014-P-0310-02	CR Tibial Insert, UHMWPE with Vitamin E, Size 3, Thickness 10mm, Right
1014-P-0311-01	CR Tibial Insert, UHMWPE with Vitamin E, Size 3, Thickness 11mm, Left
1014-P-0311-02	CR Tibial Insert, UHMWPE with Vitamin E, Size 3, Thickness 11mm, Right
1014-P-0312-01	CR Tibial Insert, UHMWPE with Vitamin E, Size 3, Thickness 12mm, Left
1014-P-0312-02	CR Tibial Insert, UHMWPE with Vitamin E, Size 3, Thickness 12mm, Right
1014-P-0313-01	CR Tibial Insert, UHMWPE with Vitamin E, Size 3, Thickness 13mm, Left
1014-P-0313-02	CR Tibial Insert, UHMWPE with Vitamin E, Size 3, Thickness 13mm, Right
1014-P-0314-01	CR Tibial Insert, UHMWPE with Vitamin E, Size 3, Thickness 14mm, Left
1014-P-0314-02	CR Tibial Insert, UHMWPE with Vitamin E, Size 3, Thickness 14mm, Right
1014-P-0315-01	CR Tibial Insert, UHMWPE with Vitamin E, Size 3, Thickness 15mm, Left
1014-P-0315-02	CR Tibial Insert, UHMWPE with Vitamin E, Size 3, Thickness 15mm, Right
1014-P-0316-01	CR Tibial Insert, UHMWPE with Vitamin E, Size 3, Thickness 16mm, Left
1014-P-0316-02	CR Tibial Insert, UHMWPE with Vitamin E, Size 3, Thickness 16mm, Right
1014-P-0317-01	CR Tibial Insert, UHMWPE with Vitamin E, Size 3, Thickness 17mm, Left
1014-P-0317-02	CR Tibial Insert, UHMWPE with Vitamin E, Size 3, Thickness 17mm, Right
1014-P-0318-01	CR Tibial Insert, UHMWPE with Vitamin E, Size 3, Thickness 18mm, Left

Catalog Number	Catalog Description
1014-P-0318-02	CR Tibial Insert, UHMWPE with Vitamin E, Size 3, Thickness 18mm, Right
1014-P-0319-01	CR Tibial Insert, UHMWPE with Vitamin E, Size 3, Thickness 19mm, Left
1014-P-0319-02	CR Tibial Insert, UHMWPE with Vitamin E, Size 3, Thickness 19mm, Right
1014-P-0409-01	CR Tibial Insert, UHMWPE with Vitamin E, Size 4, Thickness 9mm, Left
1014-P-0409-02	CR Tibial Insert, UHMWPE with Vitamin E, Size 4, Thickness 9mm, Right
1014-P-0410-01	CR Tibial Insert, UHMWPE with Vitamin E, Size 4, Thickness 10mm, Left
1014-P-0410-02	CR Tibial Insert, UHMWPE with Vitamin E, Size 4, Thickness 10mm, Right
1014-P-0411-01	CR Tibial Insert, UHMWPE with Vitamin E, Size 4, Thickness 11mm, Left
1014-P-0411-02	CR Tibial Insert, UHMWPE with Vitamin E, Size 4, Thickness 11mm, Right
1014-P-0412-01	CR Tibial Insert, UHMWPE with Vitamin E, Size 4, Thickness 12mm, Left
1014-P-0412-02	CR Tibial Insert, UHMWPE with Vitamin E, Size 4, Thickness 12mm, Right
1014-P-0413-01	CR Tibial Insert, UHMWPE with Vitamin E, Size 4, Thickness 13mm, Left
1014-P-0413-02	CR Tibial Insert, UHMWPE with Vitamin E, Size 4, Thickness 13mm, Right
1014-P-0414-01	CR Tibial Insert, UHMWPE with Vitamin E, Size 4, Thickness 14mm, Left
1014-P-0414-02	CR Tibial Insert, UHMWPE with Vitamin E, Size 4, Thickness 14mm, Right
1014-P-0415-01	CR Tibial Insert, UHMWPE with Vitamin E, Size 4, Thickness 15mm, Left
1014-P-0415-02	CR Tibial Insert, UHMWPE with Vitamin E, Size 4, Thickness 15mm, Right
1014-P-0416-01	CR Tibial Insert, UHMWPE with Vitamin E, Size 4, Thickness 16mm, Left
1014-P-0416-02	CR Tibial Insert, UHMWPE with Vitamin E, Size 4, Thickness 16mm, Right
1014-P-0417-01	CR Tibial Insert, UHMWPE with Vitamin E, Size 4, Thickness 17mm, Left
1014-P-0417-02	CR Tibial Insert, UHMWPE with Vitamin E, Size 4, Thickness 17mm, Right
1014-P-0418-01	CR Tibial Insert, UHMWPE with Vitamin E, Size 4, Thickness 18mm, Left
1014-P-0418-02	CR Tibial Insert, UHMWPE with Vitamin E, Size 4, Thickness 18mm, Right
1014-P-0419-01	CR Tibial Insert, UHMWPE with Vitamin E, Size 4, Thickness 19mm, Left
1014-P-0419-02	CR Tibial Insert, UHMWPE with Vitamin E, Size 4, Thickness 19mm, Right
1014-P-0509-01	CR Tibial Insert, UHMWPE with Vitamin E, Size 5, Thickness 9mm, Left
1014-P-0509-02	CR Tibial Insert, UHMWPE with Vitamin E, Size 5, Thickness 9mm, Right
1014-P-0510-01	CR Tibial Insert, UHMWPE with Vitamin E, Size 5, Thickness 10mm, Left
1014-P-0510-02	CR Tibial Insert, UHMWPE with Vitamin E, Size 5, Thickness 10mm, Right
1014-P-0511-01	CR Tibial Insert, UHMWPE with Vitamin E, Size 5, Thickness 11mm, Left
1014-P-0511-02	CR Tibial Insert, UHMWPE with Vitamin E, Size 5, Thickness 11mm, Right
1014-P-0512-01	CR Tibial Insert, UHMWPE with Vitamin E, Size 5, Thickness 12mm, Left
1014-P-0512-02	CR Tibial Insert, UHMWPE with Vitamin E, Size 5, Thickness 12mm, Right
1014-P-0513-01	CR Tibial Insert, UHMWPE with Vitamin E, Size 5, Thickness 13mm, Left
1014-P-0513-02	CR Tibial Insert, UHMWPE with Vitamin E, Size 5, Thickness 13mm, Right
1014-P-0514-01	CR Tibial Insert, UHMWPE with Vitamin E, Size 5, Thickness 14mm, Left
1014-P-0514-02	CR Tibial Insert, UHMWPE with Vitamin E, Size 5, Thickness 14mm, Right
1014-P-0515-01	CR Tibial Insert, UHMWPE with Vitamin E, Size 5, Thickness 15mm, Left
1014-P-0515-02	CR Tibial Insert, UHMWPE with Vitamin E, Size 5, Thickness 15mm, Right

Catalog Number	Catalog Description
1014-P-0516-01	CR Tibial Insert, UHMWPE with Vitamin E, Size 5, Thickness 16mm, Left
1014-P-0516-02	CR Tibial Insert, UHMWPE with Vitamin E, Size 5, Thickness 16mm, Right
1014-P-0517-01	CR Tibial Insert, UHMWPE with Vitamin E, Size 5, Thickness 17mm, Left
1014-P-0517-02	CR Tibial Insert, UHMWPE with Vitamin E, Size 5, Thickness 17mm, Right
1014-P-0518-01	CR Tibial Insert, UHMWPE with Vitamin E, Size 5, Thickness 18mm, Left
1014-P-0518-02	CR Tibial Insert, UHMWPE with Vitamin E, Size 5, Thickness 18mm, Right
1014-P-0519-01	CR Tibial Insert, UHMWPE with Vitamin E, Size 5, Thickness 19mm, Left
1014-P-0519-02	CR Tibial Insert, UHMWPE with Vitamin E, Size 5, Thickness 19mm, Right
1014-P-0609-01	CR Tibial Insert, UHMWPE with Vitamin E, Size 6, Thickness 9mm, Left
1014-P-0609-02	CR Tibial Insert, UHMWPE with Vitamin E, Size 6, Thickness 9mm, Right
1014-P-0610-01	CR Tibial Insert, UHMWPE with Vitamin E, Size 6, Thickness 10mm, Left
1014-P-0610-02	CR Tibial Insert, UHMWPE with Vitamin E, Size 6, Thickness 10mm, Right
1014-P-0611-01	CR Tibial Insert, UHMWPE with Vitamin E, Size 6, Thickness 11mm, Left
1014-P-0611-02	CR Tibial Insert, UHMWPE with Vitamin E, Size 6, Thickness 11mm, Right
1014-P-0612-01	CR Tibial Insert, UHMWPE with Vitamin E, Size 6, Thickness 12mm, Left
1014-P-0612-02	CR Tibial Insert, UHMWPE with Vitamin E, Size 6, Thickness 12mm, Right
1014-P-0613-01	CR Tibial Insert, UHMWPE with Vitamin E, Size 6, Thickness 13mm, Left
1014-P-0613-02	CR Tibial Insert, UHMWPE with Vitamin E, Size 6, Thickness 13mm, Right
1014-P-0614-01	CR Tibial Insert, UHMWPE with Vitamin E, Size 6, Thickness 14mm, Left
1014-P-0614-02	CR Tibial Insert, UHMWPE with Vitamin E, Size 6, Thickness 14mm, Right
1014-P-0615-01	CR Tibial Insert, UHMWPE with Vitamin E, Size 6, Thickness 15mm, Left
1014-P-0615-02	CR Tibial Insert, UHMWPE with Vitamin E, Size 6, Thickness 15mm, Right
1014-P-0616-01	CR Tibial Insert, UHMWPE with Vitamin E, Size 6, Thickness 16mm, Left
1014-P-0616-02	CR Tibial Insert, UHMWPE with Vitamin E, Size 6, Thickness 16mm, Right
1014-P-0617-01	CR Tibial Insert, UHMWPE with Vitamin E, Size 6, Thickness 17mm, Left
1014-P-0617-02	CR Tibial Insert, UHMWPE with Vitamin E, Size 6, Thickness 17mm, Right
1014-P-0618-01	CR Tibial Insert, UHMWPE with Vitamin E, Size 6, Thickness 18mm, Left
1014-P-0618-02	CR Tibial Insert, UHMWPE with Vitamin E, Size 6, Thickness 18mm, Right
1014-P-0619-01	CR Tibial Insert, UHMWPE with Vitamin E, Size 6, Thickness 19mm, Left
1014-P-0619-02	CR Tibial Insert, UHMWPE with Vitamin E, Size 6, Thickness 19mm, Right
1014-P-0709-01	CR Tibial Insert, UHMWPE with Vitamin E, Size 7, Thickness 9mm, Left
1014-P-0709-02	CR Tibial Insert, UHMWPE with Vitamin E, Size 7, Thickness 9mm, Right
1014-P-0710-01	CR Tibial Insert, UHMWPE with Vitamin E, Size 7, Thickness 10mm, Left
1014-P-0710-02	CR Tibial Insert, UHMWPE with Vitamin E, Size 7, Thickness 10mm, Right
1014-P-0711-01	CR Tibial Insert, UHMWPE with Vitamin E, Size 7, Thickness 11mm, Left
1014-P-0711-02	CR Tibial Insert, UHMWPE with Vitamin E, Size 7, Thickness 11mm, Right
1014-P-0712-01	CR Tibial Insert, UHMWPE with Vitamin E, Size 7, Thickness 12mm, Left

Catalog Number	Catalog Description
1014-P-0712-02	CR Tibial Insert, UHMWPE with Vitamin E, Size 7, Thickness 12mm, Right
1014-P-0713-01	CR Tibial Insert, UHMWPE with Vitamin E, Size 7, Thickness 13mm, Left
1014-P-0713-02	CR Tibial Insert, UHMWPE with Vitamin E, Size 7, Thickness 13mm, Right
1014-P-0714-01	CR Tibial Insert, UHMWPE with Vitamin E, Size 7, Thickness 14mm, Left
1014-P-0714-02	CR Tibial Insert, UHMWPE with Vitamin E, Size 7, Thickness 14mm, Right
1014-P-0715-01	CR Tibial Insert, UHMWPE with Vitamin E, Size 7, Thickness 15mm, Left
1014-P-0715-02	CR Tibial Insert, UHMWPE with Vitamin E, Size 7, Thickness 15mm, Right
1014-P-0716-01	CR Tibial Insert, UHMWPE with Vitamin E, Size 7, Thickness 16mm, Left
1014-P-0716-02	CR Tibial Insert, UHMWPE with Vitamin E, Size 7, Thickness 16mm, Right
1014-P-0717-01	CR Tibial Insert, UHMWPE with Vitamin E, Size 7, Thickness 17mm, Left
1014-P-0717-02	CR Tibial Insert, UHMWPE with Vitamin E, Size 7, Thickness 17mm, Right
1014-P-0718-01	CR Tibial Insert, UHMWPE with Vitamin E, Size 7, Thickness 18mm, Left
1014-P-0718-02	CR Tibial Insert, UHMWPE with Vitamin E, Size 7, Thickness 18mm, Right
1014-P-0719-01	CR Tibial Insert, UHMWPE with Vitamin E, Size 7, Thickness 19mm, Left
1014-P-0719-02	CR Tibial Insert, UHMWPE with Vitamin E, Size 7, Thickness 19mm, Right
1014-P-0809-01	CR Tibial Insert, UHMWPE with Vitamin E, Size 8, Thickness 9mm, Left
1014-P-0809-02	CR Tibial Insert, UHMWPE with Vitamin E, Size 8, Thickness 9mm, Right
1014-P-0810-01	CR Tibial Insert, UHMWPE with Vitamin E, Size 8, Thickness 10mm, Left
1014-P-0810-02	CR Tibial Insert, UHMWPE with Vitamin E, Size 8, Thickness 10mm, Right
1014-P-0811-01	CR Tibial Insert, UHMWPE with Vitamin E, Size 8, Thickness 11mm, Left
1014-P-0811-02	CR Tibial Insert, UHMWPE with Vitamin E, Size 8, Thickness 11mm, Right
1014-P-0812-01	CR Tibial Insert, UHMWPE with Vitamin E, Size 8, Thickness 12mm, Left
1014-P-0812-02	CR Tibial Insert, UHMWPE with Vitamin E, Size 8, Thickness 12mm, Right
1014-P-0813-01	CR Tibial Insert, UHMWPE with Vitamin E, Size 8, Thickness 13mm, Left
1014-P-0813-02	CR Tibial Insert, UHMWPE with Vitamin E, Size 8, Thickness 13mm, Right
1014-P-0814-01	CR Tibial Insert, UHMWPE with Vitamin E, Size 8, Thickness 14mm, Left
1014-P-0814-02	CR Tibial Insert, UHMWPE with Vitamin E, Size 8, Thickness 14mm, Right
1014-P-0815-01	CR Tibial Insert, UHMWPE with Vitamin E, Size 8, Thickness 15mm, Left
1014-P-0815-02	CR Tibial Insert, UHMWPE with Vitamin E, Size 8, Thickness 15mm, Right
1014-P-0816-01	CR Tibial Insert, UHMWPE with Vitamin E, Size 8, Thickness 16mm, Left
1014-P-0816-02	CR Tibial Insert, UHMWPE with Vitamin E, Size 8, Thickness 16mm, Right
1014-P-0817-01	CR Tibial Insert, UHMWPE with Vitamin E, Size 8, Thickness 17mm, Left
1014-P-0817-02	CR Tibial Insert, UHMWPE with Vitamin E, Size 8, Thickness 17mm, Right
1014-P-0818-01	CR Tibial Insert, UHMWPE with Vitamin E, Size 8, Thickness 18mm, Left
1014-P-0818-02	CR Tibial Insert, UHMWPE with Vitamin E, Size 8, Thickness 18mm, Right
1014-P-0819-01	CR Tibial Insert, UHMWPE with Vitamin E, Size 8, Thickness 19mm, Left
1014-P-0819-02	CR Tibial Insert, UHMWPE with Vitamin E, Size 8, Thickness 19mm, Right

HIGHLY CONGRUENT CR (HC-CR) TIBIAL INSERTS

Catalog Number	Catalog Description
1014-P-1109	Highly Congruent CR Tibial Insert, UHMWPE with Vitamin E Size 1, Thickness 9mm
1014-P-1110	Highly Congruent CR Tibial Insert, UHMWPE with Vitamin E Size 1, Thickness 10mm
1014-P-1111	Highly Congruent CR Tibial Insert, UHMWPE with Vitamin E, Size 1, Thickness 11mm
1014-P-1112	Highly Congruent CR Tibial Insert, UHMWPE with Vitamin E Size 1, Thickness 12mm
1014-P-1113	Highly Congruent CR Tibial Insert, UHMWPE with Vitamin E, Size 1, Thickness 13mm
1014-P-1114	Highly Congruent CR Tibial Insert, UHMWPE with Vitamin E Size 1, Thickness 14mm
1014-P-1115	Highly Congruent CR Tibial Insert, UHMWPE with Vitamin E, Size 1, Thickness 15mm
1014-P-1116	Highly Congruent CR Tibial Insert, UHMWPE with Vitamin E Size 1, Thickness 16mm
1014-P-1117	Highly Congruent CR Tibial Insert, UHMWPE with Vitamin E, Size 1, Thickness 17mm
1014-P-1118	Highly Congruent CR Tibial Insert, UHMWPE with Vitamin E Size 1, Thickness 18mm
1014-P-1119	Highly Congruent CR Tibial Insert, UHMWPE with Vitamin E, Size 1, Thickness 19mm
1014-P-1120	Highly Congruent CR Tibial Insert, UHMWPE with Vitamin E, Size 1, Thickness 20mm
1014-P-1121	Highly Congruent CR Tibial Insert, UHMWPE with Vitamin E, Size 1, Thickness 21mm
1014-P-1122	Highly Congruent CR Tibial Insert, UHMWPE with Vitamin E, Size 1, Thickness 22mm
1014-P-1209	Highly Congruent CR Tibial Insert, UHMWPE with Vitamin E Size 2, Thickness 9mm
1014-P-1210	Highly Congruent CR Tibial Insert, UHMWPE with Vitamin E Size 2, Thickness 10mm
1014-P-1211	Highly Congruent CR Tibial Insert, UHMWPE with Vitamin E, Size 2, Thickness 11mm
1014-P-1212	Highly Congruent CR Tibial Insert, UHMWPE with Vitamin E Size 2, Thickness 12mm
1014-P-1213	Highly Congruent CR Tibial Insert, UHMWPE with Vitamin E, Size 2, Thickness 13mm
1014-P-1214	Highly Congruent CR Tibial Insert, UHMWPE with Vitamin E Size 2, Thickness 14mm
1014-P-1215	Highly Congruent CR Tibial Insert, UHMWPE with Vitamin E, Size 2, Thickness 15mm
1014-P-1216	Highly Congruent CR Tibial Insert, UHMWPE with Vitamin E Size 2, Thickness 16mm
1014-P-1217	Highly Congruent CR Tibial Insert, UHMWPE with Vitamin E, Size 2, Thickness 17mm
1014-P-1218	Highly Congruent CR Tibial Insert, UHMWPE with Vitamin E Size 2, Thickness 18mm
1014-P-1219	Highly Congruent CR Tibial Insert, UHMWPE with Vitamin E, Size 2, Thickness 19mm
1014-P-1220	Highly Congruent CR Tibial Insert, UHMWPE with Vitamin E, Size 2, Thickness 20mm
1014-P-1221	Highly Congruent CR Tibial Insert, UHMWPE with Vitamin E, Size 2, Thickness 21mm
1014-P-1222	Highly Congruent CR Tibial Insert, UHMWPE with Vitamin E, Size 2, Thickness 22mm
1014-P-1309	Highly Congruent CR Tibial Insert, UHMWPE with Vitamin E Size 3, Thickness 9mm
1014-P-1310	Highly Congruent CR Tibial Insert, UHMWPE with Vitamin E Size 3, Thickness 10mm
1014-P-1311	Highly Congruent CR Tibial Insert, UHMWPE with Vitamin E, Size 3, Thickness 11mm
1014-P-1312	Highly Congruent CR Tibial Insert, UHMWPE with Vitamin E Size 3, Thickness 12mm
1014-P-1313	Highly Congruent CR Tibial Insert, UHMWPE with Vitamin E, Size 3, Thickness 13mm
1014-P-1314	Highly Congruent CR Tibial Insert, UHMWPE with Vitamin E Size 3, Thickness 14mm
1014-P-1315	Highly Congruent CR Tibial Insert, UHMWPE with Vitamin E, Size 3, Thickness 15mm
1014-P-1316	Highly Congruent CR Tibial Insert, UHMWPE with Vitamin E Size 3, Thickness 16mm
1014-P-1317	Highly Congruent CR Tibial Insert, UHMWPE with Vitamin E, Size 3, Thickness 17mm
1014-P-1318	Highly Congruent CR Tibial Insert, UHMWPE with Vitamin E Size 3, Thickness 18mm



Blue Total Knee System

Surgical Technique Guide

1014-P-1319	Highly Congruent CR Tibial Insert, UHMWPE with Vitamin E, Size 3, Thickness 19mm
1014-P-1320	Highly Congruent CR Tibial Insert, UHMWPE with Vitamin E, Size 3, Thickness 20mm
1014-P-1321	Highly Congruent CR Tibial Insert, UHMWPE with Vitamin E, Size 3, Thickness 21mm
1014-P-1322	Highly Congruent CR Tibial Insert, UHMWPE with Vitamin E, Size 3, Thickness 22mm
1014-P-1409	Highly Congruent CR Tibial Insert, UHMWPE with Vitamin E Size 4, Thickness 9mm
1014-P-1410	Highly Congruent CR Tibial Insert, UHMWPE with Vitamin E Size 4, Thickness 10mm
1014-P-1411	Highly Congruent CR Tibial Insert, UHMWPE with Vitamin E, Size 4, Thickness 11mm
1014-P-1412	Highly Congruent CR Tibial Insert, UHMWPE with Vitamin E Size 4, Thickness 12mm
1014-P-1413	Highly Congruent CR Tibial Insert, UHMWPE with Vitamin E, Size 4, Thickness 13mm
1014-P-1414	Highly Congruent CR Tibial Insert, UHMWPE with Vitamin E Size 4, Thickness 14mm
1014-P-1415	Highly Congruent CR Tibial Insert, UHMWPE with Vitamin E, Size 4, Thickness 15mm
1014-P-1416	Highly Congruent CR Tibial Insert, UHMWPE with Vitamin E Size 4, Thickness 16mm
1014-P-1417	Highly Congruent CR Tibial Insert, UHMWPE with Vitamin E, Size 4, Thickness 17mm
1014-P-1418	Highly Congruent CR Tibial Insert, UHMWPE with Vitamin E Size 4, Thickness 18mm
1014-P-1419	Highly Congruent CR Tibial Insert, UHMWPE with Vitamin E, Size 4, Thickness 19mm
1014-P-1420	Highly Congruent CR Tibial Insert, UHMWPE with Vitamin E, Size 4, Thickness 20mm
1014-P-1421	Highly Congruent CR Tibial Insert, UHMWPE with Vitamin E, Size 4, Thickness 21mm
1014-P-1422	Highly Congruent CR Tibial Insert, UHMWPE with Vitamin E, Size 4, Thickness 22mm
1014-P-1509	Highly Congruent CR Tibial Insert, UHMWPE with Vitamin E Size 5, Thickness 9mm
1014-P-1510	Highly Congruent CR Tibial Insert, UHMWPE with Vitamin E Size 5, Thickness 10mm
1014-P-1511	Highly Congruent CR Tibial Insert, UHMWPE with Vitamin E, Size 5, Thickness 11mm
1014-P-1512	Highly Congruent CR Tibial Insert, UHMWPE with Vitamin E Size 5, Thickness 12mm
1014-P-1513	Highly Congruent CR Tibial Insert, UHMWPE with Vitamin E, Size 5, Thickness 13mm
1014-P-1514	Highly Congruent CR Tibial Insert, UHMWPE with Vitamin E Size 5, Thickness 14mm
1014-P-1515	Highly Congruent CR Tibial Insert, UHMWPE with Vitamin E, Size 5, Thickness 15mm
1014-P-1516	Highly Congruent CR Tibial Insert, UHMWPE with Vitamin E Size 5, Thickness 16mm
1014-P-1517	Highly Congruent CR Tibial Insert, UHMWPE with Vitamin E, Size 5, Thickness 17mm
1014-P-1518	Highly Congruent CR Tibial Insert, UHMWPE with Vitamin E Size 5, Thickness 18mm
1014-P-1519	Highly Congruent CR Tibial Insert, UHMWPE with Vitamin E, Size 5, Thickness 19mm
1014-P-1520	Highly Congruent CR Tibial Insert, UHMWPE with Vitamin E, Size 5, Thickness 20mm
1014-P-1521	Highly Congruent CR Tibial Insert, UHMWPE with Vitamin E, Size 5, Thickness 21mm
1014-P-1522	Highly Congruent CR Tibial Insert, UHMWPE with Vitamin E, Size 5, Thickness 22mm
1014-P-1609	Highly Congruent CR Tibial Insert, UHMWPE with Vitamin E Size 6, Thickness 9mm
1014-P-1610	Highly Congruent CR Tibial Insert, UHMWPE with Vitamin E Size 6, Thickness 10mm
1014-P-1611	Highly Congruent CR Tibial Insert, UHMWPE with Vitamin E, Size 6, Thickness 11mm
1014-P-1612	Highly Congruent CR Tibial Insert, UHMWPE with Vitamin E Size 6, Thickness 12mm
1014-P-1613	Highly Congruent CR Tibial Insert, UHMWPE with Vitamin E, Size 6, Thickness 13mm
1014-P-1614	Highly Congruent CR Tibial Insert, UHMWPE with Vitamin E Size 6, Thickness 14mm
1014-P-1615	Highly Congruent CR Tibial Insert, UHMWPE with Vitamin E, Size 6, Thickness 15mm
1014-P-1616	Highly Congruent CR Tibial Insert, UHMWPE with Vitamin E Size 6, Thickness 16mm

Optimotion Implants Blue Total Knee System



Surgical Technique Guide

1014-P-1617	Highly Congruent CR Tibial Insert, UHMWPE with Vitamin E, Size 6, Thickness 17mm
1014-P-1618	Highly Congruent CR Tibial Insert, UHMWPE with Vitamin E, Size 6, Thickness 18mm
1014-P-1619	Highly Congruent CR Tibial Insert, UHMWPE with Vitamin E, Size 6, Thickness 19mm
1014-P-1620	Highly Congruent CR Tibial Insert, UHMWPE with Vitamin E, Size 6, Thickness 20mm
1014-P-1621	Highly Congruent CR Tibial Insert, UHMWPE with Vitamin E, Size 6, Thickness 21mm
1014-P-1622	Highly Congruent CR Tibial Insert, UHMWPE with Vitamin E, Size 6, Thickness 22mm
1014-P-1709	Highly Congruent CR Tibial Insert, UHMWPE with Vitamin E, Size 7, Thickness 9mm
1014-P-1710	Highly Congruent CR Tibial Insert, UHMWPE with Vitamin E, Size 7, Thickness 10mm
1014-P-1711	Highly Congruent CR Tibial Insert, UHMWPE with Vitamin E, Size 7, Thickness 11mm
1014-P-1712	Highly Congruent CR Tibial Insert, UHMWPE with Vitamin E, Size 7, Thickness 12mm
1014-P-1713	Highly Congruent CR Tibial Insert, UHMWPE with Vitamin E, Size 7, Thickness 13mm
1014-P-1714	Highly Congruent CR Tibial Insert, UHMWPE with Vitamin E, Size 7, Thickness 14mm
1014-P-1715	Highly Congruent CR Tibial Insert, UHMWPE with Vitamin E, Size 7, Thickness 15mm
1014-P-1716	Highly Congruent CR Tibial Insert, UHMWPE with Vitamin E, Size 7, Thickness 16mm
1014-P-1717	Highly Congruent CR Tibial Insert, UHMWPE with Vitamin E, Size 7, Thickness 17mm
1014-P-1718	Highly Congruent CR Tibial Insert, UHMWPE with Vitamin E, Size 7, Thickness 18mm
1014-P-1719	Highly Congruent CR Tibial Insert, UHMWPE with Vitamin E, Size 7, Thickness 19mm
1014-P-1720	Highly Congruent CR Tibial Insert, UHMWPE with Vitamin E, Size 7, Thickness 20mm
1014-P-1721	Highly Congruent CR Tibial Insert, UHMWPE with Vitamin E, Size 7, Thickness 21mm
1014-P-1722	Highly Congruent CR Tibial Insert, UHMWPE with Vitamin E, Size 7, Thickness 22mm
1014-P-1809	Highly Congruent CR Tibial Insert, UHMWPE with Vitamin E, Size 8, Thickness 9mm
1014-P-1810	Highly Congruent CR Tibial Insert, UHMWPE with Vitamin E, Size 8, Thickness 10mm
1014-P-1811	Highly Congruent CR Tibial Insert, UHMWPE with Vitamin E, Size 8, Thickness 11mm
1014-P-1812	Highly Congruent CR Tibial Insert, UHMWPE with Vitamin E, Size 8, Thickness 12mm
1014-P-1813	Highly Congruent CR Tibial Insert, UHMWPE with Vitamin E, Size 8, Thickness 13mm
1014-P-1814	Highly Congruent CR Tibial Insert, UHMWPE with Vitamin E, Size 8, Thickness 14mm
1014-P-1815	Highly Congruent CR Tibial Insert, UHMWPE with Vitamin E, Size 8, Thickness 15mm
1014-P-1816	Highly Congruent CR Tibial Insert, UHMWPE with Vitamin E, Size 8, Thickness 16mm
1014-P-1817	Highly Congruent CR Tibial Insert, UHMWPE with Vitamin E, Size 8, Thickness 17mm
1014-P-1818	Highly Congruent CR Tibial Insert, UHMWPE with Vitamin E, Size 8, Thickness 18mm
1014-P-1819	Highly Congruent CR Tibial Insert, UHMWPE with Vitamin E, Size 8, Thickness 19mm
1014-P-1820	Highly Congruent CR Tibial Insert, UHMWPE with Vitamin E, Size 8, Thickness 20mm
1014-P-1821	Highly Congruent CR Tibial Insert, UHMWPE with Vitamin E, Size 8, Thickness 21mm
1014-P-1822	Highly Congruent CR Tibial Insert, UHMWPE with Vitamin E, Size 8, Thickness 22mm

PATELLA COMPONENTS

Catalog Number	Catalog Description
1014-P-2708	Patella, UHMWPE with Vitamin E, 27mm x 8mm
1014-P-2908	Patella, UHMWPE with Vitamin E, 29mm x 8mm
1014-P-3109	Patella, UHMWPE with Vitamin E, 30mm x 9mm
1014-P-3309	Patella, UHMWPE with Vitamin E, 33mm x 9mm
1014-P-3610	Patella, UHMWPE with Vitamin E, 36mm x 10mm
1014-P-3911	Patella, UHMWPE with Vitamin E, 39mm x 11mm

Surgical Instrumentation

Catalog Number	Catalog Description	Representative Illustration
1014-1-0001	FEMORAL IM ROD	
1014-1-0002	FEMORAL IM ROD HANDLE	
1014-1-0003	FEMORAL ANGULAR ALIGNMENT GUIDE	

Catalog Number	Catalog Description	Representative Illustration
1014-1-0004	DISTAL FEMORAL ALIGNMENT GUIDE	
1014-1-0005	DISTAL FEMORAL CUT BLOCK	
1014-1-1001	FEMORAL CHAMFER CUT BLOCK SZ1	
1014-1-1002	FEMORAL CHAMFER CUT BLOCK SZ2	
1014-1-1003	FEMORAL CHAMFER CUT BLOCK SZ3	
1014-1-1004	FEMORAL CHAMFER CUT BLOCK SZ4	
1014-1-1005	FEMORAL CHAMFER CUT BLOCK SZ5	
1014-1-1006	FEMORAL CHAMFER CUT BLOCK SZ6	
1014-1-1007	FEMORAL CHAMFER CUT BLOCK SZ7	
1014-1-1008	FEMORAL CHAMFER CUT BLOCK SZ8	
1014-1-2001	FEMORAL TRIAL UNIVERSAL SZ 1	
1014-1-2002	FEMORAL TRIAL UNIVERSAL SZ 2	
1014-1-2003	FEMORAL TRIAL UNIVERSAL SZ 3	
1014-1-2004	FEMORAL TRIAL UNIVERSAL SZ 4	
1014-1-2005	FEMORAL TRIAL UNIVERSAL SZ 5	
1014-1-2006	FEMORAL TRIAL UNIVERSAL SZ 6	
1014-1-2007	FEMORAL TRIAL UNIVERSAL SZ 7	
1014-1-2008	FEMORAL TRIAL UNIVERSAL SZ 8	
1014-1-2101	FEMORAL TRIAL INSERT CR SIZE 1	
1014-1-2102	FEMORAL TRIAL INSERT CR SIZE 2	
1014-1-2103	FEMORAL TRIAL INSERT CR SIZE 3	
1014-1-2104	FEMORAL TRIAL INSERT CR SIZE 4	
1014-1-2105	FEMORAL TRIAL INSERT CR SIZE 5	
1014-1-2106	FEMORAL TRIAL INSERT CR SIZE 6	
1014-1-2107	FEMORAL TRIAL INSERT CR SIZE 7	
1014-1-2108	FEMORAL TRIAL INSERT CR SIZE 8	

Catalog Number	Catalog Description	Representative Illustration
1014-1-0048	FEMORAL DRILL	
1014-1-0051	FEMORAL IMPACTOR	
1014-1-0052	FEMORAL DRIVER	
1014-1-0053	3.2MM FLUTED PIN	
1014-1-0055	PIN PULLER	

Catalog Number	Catalog Description	Representative Illustration
1014-1-0056	ANGEL WING	
1014-1-0057	FEMORAL SIZER	
1014-1-0058	FEMORAL TRIAL INSERTER	
1014-1-0059	FEMORAL CR AUX PEG DRILL	

Catalog Number	Catalog Description	Representative Illustration
1014-1-0061	CURVED OSTEOTOME	
1014-1-0071	FEMORAL IMPACTOR-SLAP HAMMER ADAPTER	
1014-2-0030	EM GUIDE ASSEMBLY	
1014-2-0002	TIBIAL RESECTION GUIDE ASSEMBLY	





Catalog Number	Catalog Description	Representative Illustration
1014-2-0004	TIBIAL STYLUS 4 & 9MM	
1014-2-0008	TIBIAL STYLUS 2 & 11mm	
1014-2-0005	TIBIAL TEMPLATE HANDLE	
1014-2-0006	3.2MM HEADED PIN	
1014-2-0007	TIBIAL TRAY CENTRAL DRILL 16MM	

Catalog Number	Catalog Description	Representative Illustration
1014-2-0009	TIBIAL TRAY CENTRAL DRILL 17MM	
1014-2-0010	AUXILLARY PEG PUNCH SHORT	
1014-2-0014	AUXILLARY PEG PUNCH LONG	
1014-2-0011	EM GDE-RESCTN GDE CONCTR 3 DGE	
1014-2-0012	EM GDE-RESCTN GDE CONCTR 0 DGE	
1014-2-0013	TIBIAL KEEL PUNCH GDE SZ 1,2,3	
1014-2-1456	TIBIAL KEEL PUNCH GDE SZ 4,5,6	
1014-2-1078	TIBIAL KEEL PUNCH GDE SZ 7,8	

Catalog Number	Catalog Description	Representative Illustration
1014-2-0029	DYNAMIC GAP BALANCING GAGE	 <p>A surgical instrument with a grey metal frame and a bright orange ergonomic handle. It features a complex mechanism with multiple circular plates and a central pivot point, used for measuring and balancing the joint gap during knee surgery.</p>
1014-2-0017	TIBIAL INSERT IMPACTOR	 <p>A long, slender surgical instrument with a black handle and a grey metal shaft, used for precisely positioning and impacting a tibial insert.</p>
1014-2-0031	TIBIAL TRAY IMPACTOR	 <p>A compact, grey metal surgical instrument with a textured surface and a small handle, used for impacting a tibial tray.</p>
1014-2-0032	MCL RETRACTOR LEFT	 <p>A thin, curved metal surgical instrument with a hook-like end and a handle, used to retract the medial collateral ligament (MCL) on the left side of the knee.</p>

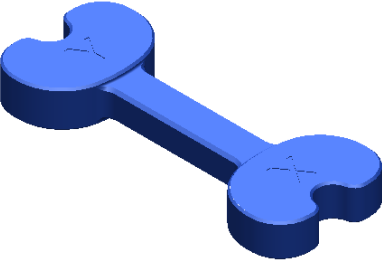
Catalog Number	Catalog Description	Representative Illustration
1014-2-0033	MCL RETRACTOR RIGHT	
1014-2-0034	IMPACTOR HANDLE	
1014-2-0022	3.5MM HEX DRIVER	
1014-2-0035	2.5MM HEX DRIVER	
1014-2-0023	TIBIAL TRAY EXTRACTOR	
1014-2-0024	SLAP HAMMER	

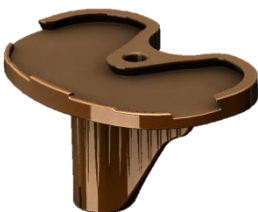

Catalog Number	Catalog Description	Representative Illustration
1014-2-0025	Z-RETRACTOR	
1014-2-0036	STATIONARY TIBIAL RESECTION GUIDE	
1014-2-0041	10MM TIBIAL STEM DRILL BUSHING	
1014-2-0042	11MM TIBIAL STEM DRILL BUSHING	
1014-2-0043	12MM TIBIAL STEM DRILL BUSHING	
1014-2-0044	13MM TIBIAL STEM DRILL BUSHING	
1014-2-0045	14MM TIBIAL STEM DRILL BUSHING	
1014-2-0048	10MM STEM DRILL	
1014-2-0050	12MM STEM DRILL	
1014-2-0052	14MM STEM DRILL	
1014-2-0054	16MM STEM DRILL	
1014-2-0056	18MM STEM DRILL	
1014-2-0058	20MM STEM DRILL	
1014-2-0060	22MM STEM DRILL	



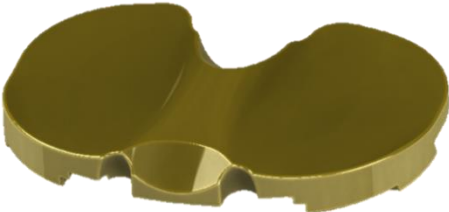

Catalog Number	Catalog Description	Representative Illustration
1014-2-0911	GAP GAGE 9MM AND 11MM	
1014-2-1315	GAP GAGE 13MM AND 15MM	
1014-2-1719	GAP GAGE 17MM AND 19MM	
1014-2-2123	TIBIAL KEEL PUNCH SZ 1,2,3	
1014-2-2456	TIBIAL KEEL PUNCH SZ 4,5,6	
1014-2-2078	TIBIAL KEEL PUNCH SZ 7,8	
1014-2-3001	TIBIAL TRAY TEMPLATE SZ 1	
1014-2-3002	TIBIAL TRAY TEMPLATE SZ 2	
1014-2-3003	TIBIAL TRAY TEMPLATE SZ 3	
1014-2-3004	TIBIAL TRAY TEMPLATE SZ 4	
1014-2-3005	TIBIAL TRAY TEMPLATE SZ 5	
1014-2-3006	TIBIAL TRAY TEMPLATE SZ 6	
1014-2-3007	TIBIAL TRAY TEMPLATE SZ 7	
1014-2-3008	TIBIAL TRAY TEMPLATE SZ 8	
1014-2-4001	TIBIAL TRAY TRIAL SIZE-1	
1014-2-4002	TIBIAL TRAY TRIAL SIZE-2	
1014-2-4003	TIBIAL TRAY TRIAL SIZE-3	
1014-2-4004	TIBIAL TRAY TRIAL SIZE-4	
1014-2-4005	TIBIAL TRAY TRIAL SIZE-5	
1014-2-4006	TIBIAL TRAY TRIAL SIZE-6	
1014-2-4007	TIBIAL TRAY TRIAL SIZE-7	
1014-2-4008	TIBIAL TRAY TRIAL SIZE-8	
1014-4-0061	TIBIAL INSERT TRIAL 6MM SHIM- SZ 1	
1014-4-0062	TIBIAL INSERT TRIAL 6MM SHIM- SZ 2	
1014-4-0063	TIBIAL INSERT TRIAL 6MM SHIM- SZ 3	
1014-4-0064	TIBIAL INSERT TRIAL 6MM SHIM- SZ 4	
1014-4-0065	TIBIAL INSERT TRIAL 6MM SHIM- SZ 5	
1014-4-0066	TIBIAL INSERT TRIAL 6MM SHIM- SZ 6	
1014-4-0067	TIBIAL INSERT TRIAL 6MM SHIM- SZ 7	
1014-4-0068	TIBIAL INSERT TRIAL 6MM SHIM- SZ 8	

Optimotion Implants Blue Total Knee System





Surgical Technique Guide

Catalog Number	Catalog Description	Representative Illustration
1014-4-1009	TIBIAL INSERT TRIAL CR UNIV-SZ 1, 9MM	
1014-4-1010	TIBIAL INSERT TRIAL CR UNIV-SZ 1, 10MM	
1014-4-1011	TIBIAL INSERT TRIAL CR UNIV-SZ 1, 11MM	
1014-4-1012	TIBIAL INSERT TRIAL CR UNIV-SZ 1, 12MM	
1014-4-1013	TIBIAL INSERT TRIAL CR UNIV-SZ 1, 13MM	
1014-4-1014	TIBIAL INSERT TRIAL CR UNIV-SZ 1, 14MM	
1014-4-2009	TIBIAL INSERT TRIAL CR UNIV-SZ 2, 9MM	
1014-4-2010	TIBIAL INSERT TRIAL CR UNIV-SZ 2, 10MM	
1014-4-2011	TIBIAL INSERT TRIAL CR UNIV-SZ 2, 11MM	
1014-4-2012	TIBIAL INSERT TRIAL CR UNIV-SZ 2, 12MM	
1014-4-2013	TIBIAL INSERT TRIAL CR UNIV-SZ 2, 13MM	
1014-4-2014	TIBIAL INSERT TRIAL CR UNIV-SZ 2, 14MM	
1014-4-3009	TIBIAL INSERT TRIAL CR UNIV-SZ 3, 9MM	
1014-4-3010	TIBIAL INSERT TRIAL CR UNIV-SZ 3, 10MM	
1014-4-3011	TIBIAL INSERT TRIAL CR UNIV-SZ 3, 11MM	
1014-4-3012	TIBIAL INSERT TRIAL CR UNIV-SZ 3, 12MM	
1014-4-3013	TIBIAL INSERT TRIAL CR UNIV-SZ 3, 13MM	
1014-4-3014	TIBIAL INSERT TRIAL CR UNIV-SZ 3, 14MM	
1014-4-4009	TIBIAL INSERT TRIAL CR UNIV-SZ 4, 9MM	
1014-4-4010	TIBIAL INSERT TRIAL CR UNIV-SZ 4, 10MM	
1014-4-4011	TIBIAL INSERT TRIAL CR UNIV-SZ 4, 11MM	
1014-4-4012	TIBIAL INSERT TRIAL CR UNIV-SZ 4, 12MM	
1014-4-4013	TIBIAL INSERT TRIAL CR UNIV-SZ 4, 13MM	
1014-4-4014	TIBIAL INSERT TRIAL CR UNIV-SZ 4, 14MM	
1014-4-5009	TIBIAL INSERT TRIAL CR UNIV-SZ 5, 9MM	
1014-4-5010	TIBIAL INSERT TRIAL CR UNIV-SZ 5, 10MM	
1014-4-5011	TIBIAL INSERT TRIAL CR UNIV-SZ 5, 11MM	
1014-4-5012	TIBIAL INSERT TRIAL CR UNIV-SZ 5, 12MM	
1014-4-5013	TIBIAL INSERT TRIAL CR UNIV-SZ 5, 13MM	
1014-4-5014	TIBIAL INSERT TRIAL CR UNIV-SZ 5, 14MM	
1014-4-6009	TIBIAL INSERT TRIAL CR UNIV-SZ 6, 9MM	
1014-4-6010	TIBIAL INSERT TRIAL CR UNIV-SZ 6, 10MM	
1014-4-6011	TIBIAL INSERT TRIAL CR UNIV-SZ 6, 11MM	

Catalog Number	Catalog Description	Representative Illustration
1014-4-6012	TIBIAL INSERT TRIAL CR UNIV-SZ 6, 12MM	
1014-4-6013	TIBIAL INSERT TRIAL CR UNIV-SZ 6, 13MM	
1014-4-6014	TIBIAL INSERT TRIAL CR UNIV-SZ 6, 14MM	
1014-4-7009	TIBIAL INSERT TRIAL CR UNIV-SZ 7, 9MM	
1014-4-7010	TIBIAL INSERT TRIAL CR UNIV-SZ 7, 10MM	
1014-4-7011	TIBIAL INSERT TRIAL CR UNIV-SZ 7, 11MM	
1014-4-7012	TIBIAL INSERT TRIAL CR UNIV-SZ 7, 12MM	
1014-4-7013	TIBIAL INSERT TRIAL CR UNIV-SZ 7, 13MM	
1014-4-7014	TIBIAL INSERT TRIAL CR UNIV-SZ 7, 14MM	
1014-4-8009	TIBIAL INSERT TRIAL CR UNIV-SZ 8, 9MM	
1014-4-8010	TIBIAL INSERT TRIAL CR UNIV-SZ 8, 10MM	
1014-4-8011	TIBIAL INSERT TRIAL CR UNIV-SZ 8, 11MM	
1014-4-8012	TIBIAL INSERT TRIAL CR UNIV-SZ 8, 12MM	
1014-4-8013	TIBIAL INSERT TRIAL CR UNIV-SZ 8, 13MM	
1014-4-8014	TIBIAL INSERT TRIAL CR UNIV-SZ 8, 14MM	
1014-3-2708	PATELLA TRIAL 27MM X 8MM	
1014-3-2908	PATELLA TRIAL 29MM X 8MM	
1014-3-3109	PATELLA TRIAL 31MM X 9MM	
1014-3-3309	PATELLA TRIAL 33MM X 9MM	
1014-3-3610	PATELLA TRIAL 36MM X 10MM	
1014-3-3911	PATELLA TRIAL 39MM X 11MM	
1014-3-0033	PATELLA SIZER 33MM	
1014-3-0036	PATELLA SIZER 36MM	
1014-3-0039	PATELLA SIZER 39MM	
1014-3-0009	PATELLA STYLUS 9MM	
1014-3-0010	PATELLA STYLUS 10MM	

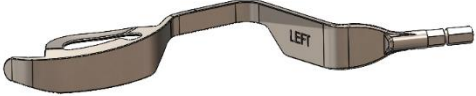
Catalog Number	Catalog Description	Representative Illustration
1014-3-0019	PATELLA CLAMP	
1014-3-0012	PATELLA RESECTION GUIDE-LEFT	
1014-3-0013	PATELLA RESECTION GUIDE-RIGHT	
1014-3-0014	PATELLA DRILL	
1014-3-0015	PATELLA DRILL GUIDE	
1014-3-0016	PATELLA CEMENT CLAMP-ANT SIDE	
1014-3-0017	PATELLA CEMENT CLAMP-POST SIDE	

Lateral Retractor Set

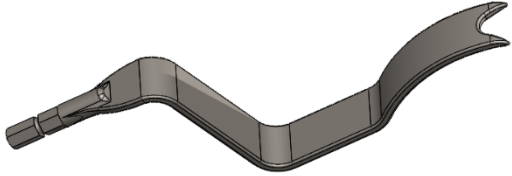
Catalog Number	Catalog Description	Representative Illustration
1014-5-0001	MCL RETRACTOR LEFT	
1014-5-0002	MCL RETRACTOR RIGHT	
1014-5-0003	SHORT MCL RETRACTOR LEFT	
1014-5-0004	SHORT MCL RETRACTOR RIGHT	
1014-5-0005	SHALLOW Z RETRACTOR	

Catalog Number	Catalog Description	Representative Illustration
1014-5-0006	DEEP Z RETRACTOR	
1014-5-0007	45 DEGREE MENISCAL DISSECTOR	
1014-5-0008	45 DEGREE KNEE RETRACTOR	
1014-5-0009	30 DEGREE MENISCAL DISSECTOR	
1014-5-1001	RETRACTOR HANDLE- REGULAR	
1014-5-1002	RETRACTOR HANDLE- SMALL	